

(PL) Instrukcja montażu

(GB) Assembly instructions

(DE) Montageanleitung

(FR) Notice de montage

(IT) Istruzioni di montaggio

(NL) Montage-instructies

Nazwa /Name /Name /Nom /Nome /Namm

RIVA CARRE 10x6

UWAGA /REMARQUE /N /NOTE /ATTENZIONE /HINWEIS /LETOP

(PL) Objętość wody w basenie 68,21 m³

(FR) Le volume de l'eau dans la piscine 68,21 m³

(GB) Water capacity in the pool 68,21 m³

(IT) Il volume di acqua in piscina 68,21 m³

(DE) Volumen von Wasser im Schwimmbecken 68,21 m³

(NL) Water inhoud van het zwembad 68,21 m³

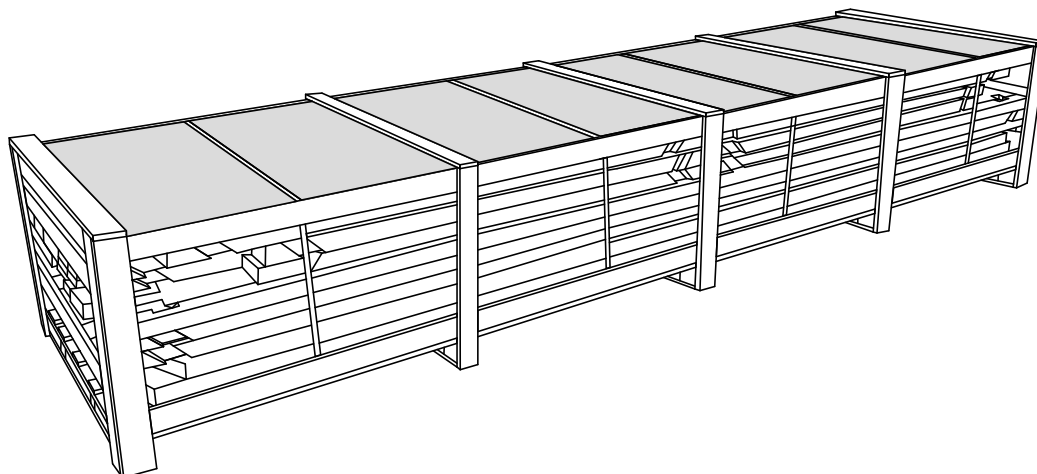
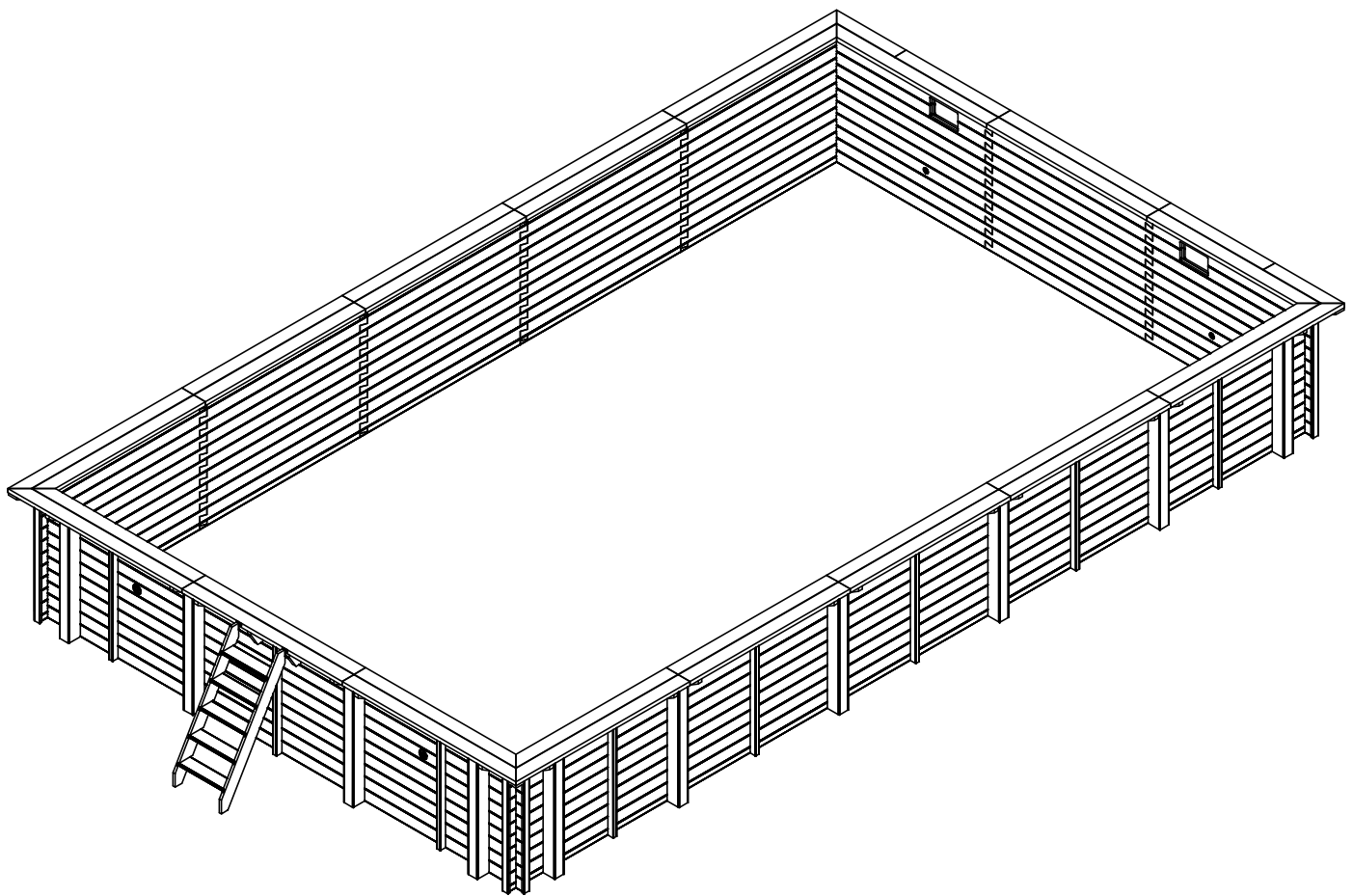

(PL) Instrukcja montażu

(GB) Assembly instructions

(DE) Montageanleitung

(FR) Notice de montage

(IT) Istruzioni di montaggio

(NL) Montage-instructies



(PL) Przed przystąpieniem do montażu zapoznaj się z instrukcją.

(FR) Avant le montage lisez attentivement la notice.

(GB) Read carefully pool installation manual before the installation.

(IT) Prima del montaggio é necessario consultare il manuale.

(DE) Vor der Montage machen Sie sich bitte mit der Bedienungsanleitung bekannt.

(NL) Lees aandachtig de montage instructie van het zwembad voor de installatie.

UWAGA / REMARQUE / NOTE / ATATTENZIONE / HINWEIS / LETOP

Instrukcja, którą posiadacie Państwo w ręku pokazuje krok po kroku w jaki sposób dokonać właściwego montażu basenu. Dołożyliśmy wszelkich starań, aby przygotować materiały jak najbardziej odzwierciedlające stan faktyczny i wygląd poszczególnych elementów. Jednak proszę pamiętać, że wszelkie rysunki mają charakter poglądowy i istnieje możliwość, że poszczególne elementy dostarczone w Państwa zestawie w rzeczywistości mogą odbiegać wyglądem od ich wizualizacji graficznej zawartej w instrukcji.

(PL)

Le manuel que vous avez entre les mains montre étape par étape comment assembler correctement la piscine. Nous avons fait tous les efforts pour préparer les documents reflétant autant que possible l'état réel et l'apparence des éléments particuliers. Pourtant, il faut savoir que tous les dessins sont présentés à titre de référence et qu'il est possible que les éléments singuliers fournis dans votre kit puissent différer en apparence de leur visualisation graphique incluse dans le manuel.

(FR)

This manual presents the correct assembly procedure for the swimming pool, step by step. We have undertaken all possible efforts to make sure that the materials are as close to the actual items and present their layout as closely as possible. Please remember, however, that all figures are indicative only and individual elements delivered in your set may be different than their graphical visualisations presented in the manual.

(GB)

Le presenti istruzioni spiegano passo dopo passo come montare correttamente la piscina. Abbiamo fatto del nostro meglio per preparare i materiali che rispecchiano il più fedelmente possibile lo stato reale e l'aspetto dei singoli elementi. Occorre però ricordare che le figure hanno carattere illustrativo ed è possibile che i singoli elementi forniti nel Vostro kit avranno l'aspetto diverso dalla loro visualizzazione grafica contenuta nelle istruzioni.

(IT)

Die Ihnen vorliegende Anleitung erläutert Ihnen Schritt für Schritt, wie das Schwimmbecken korrekt montiert wird. Wir haben alles daran gesetzt, die Unterlagen bestmöglich an den tatsächlichen Zustand und das Aussehen der einzelnen Teile anzupassen. Bitte bedenken Sie jedoch, dass alle Zeichnungen nur zu Anschauungszwecken dienen. Deshalb kann es sein, dass einzelne Teile in Ihrem Set anders aussehen, als in der graphischen Visualisierung in der Anleitung.

(DE)

De handleiding die u in uw handen hebt, laat stap voor stap zien hoe u het zwembad op de juiste manier zult monteren. We hebben er alles aan gedaan om een handleiding voor te bereiden die zoveel mogelijk de werkelijke toestand en het uiterlijk van individuele elementen weergeven. Houd er echter rekening mee dat alle tekeningen alleen ter referentie dienen en dat het mogelijk is dat de afzonderlijke elementen in uw set in hun uiterlijk kunnen afwijken van hun grafische visualisatie in de handleiding.

(NL)

(PL) Instrukcja montażu

(GB) Assembly instructions

(DE) Montageanleitung

(FR) Notice de montage

(IT) Istruzioni di montaggio

(NL) Montage-instructies



(PL) Przed przystąpieniem do montażu zapoznaj się z instrukcją. *Bez wylewki betonowej.
(FR) Avant le montage lisez attentivement la notice. *Sans la dalle en béton.
(GB) Read carefully pool installation manual before the installation. *Without concrete base.
(IT) Prima del montaggio é necessario consultare il manuale. *Senza una lastra di cemento.
(DE) Vor der Montage machen Sie sich bitte mit der Bedienungsanleitung bekannt. *Ohne Betonestrich.
(NL) Lees aandachtig de montage instructie van het zwembad voor de installatie. *Zonder betonnen sokkel.

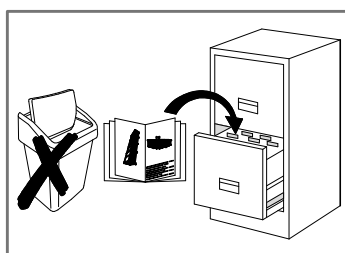
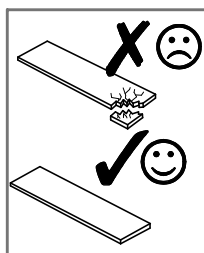
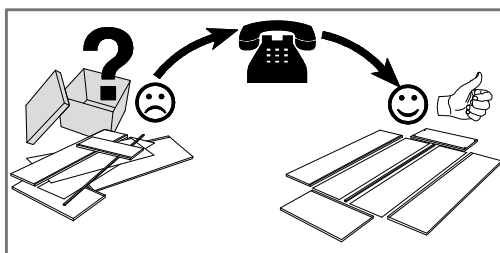
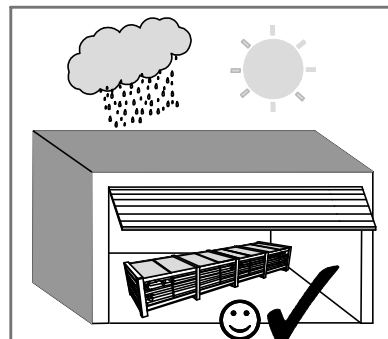
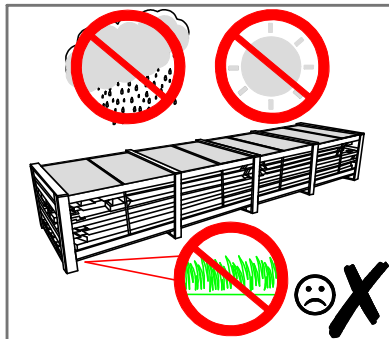
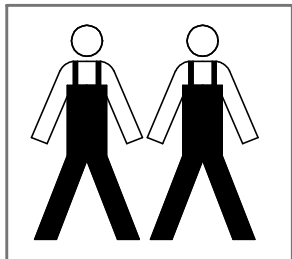
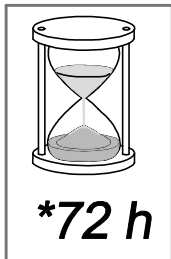

UWAGA /REMARQUE /NOTE/ ATATTENZIONE /HINWEIS /LETOP

(PL) Montaż wykonać w przeciągu 3 dni od rozpakowania struktury.
(FR) Il faut monter la structure au cours de 3 jours de l'ouverture du colis.
(GB) Installation should be finished within 3 days from opening the package.
(IT) Il montaggio effettuare entro 3 giorni dal disimballo della struttura.
(DE) Die Montage ist innerhalb von 3 Tagen zu machen, nachdem die Konstruktion geöffnet wird.
(NL) De installatie moet worden afgewerkt binnen 3 dagen na het openen van de verpakking.



UWAGA /REMARQUE /NOTE/ ATATTENZIONE /HINWEIS /LETOP

(PL) Brak corocznej konserwacji struktury powoduje utratę gwarancji.
(FR) Le manque de la conseravtion annuelle de la structure cause la perte de la garantie.
(GB) Lack of once a year conservation of the structure causes loss of warranty.
(IT) Mancanza della manutenzione annuale causa la perdita di garanzia.
(DE) Keine jährliche Wartung der Konstruktion macht das, das die Garantie verloren geht.
(NL) Behandel elk jaar de buitenkant van het zwembad met een beits, anders vervalt de garantie.



UWAGA /REMARQUE /NOTE/ ATATTENZIONE /HINWEIS /LETOP

(PL) Nie pozostawiać dzieci bez nadzoru!
(FR) Ne laissez pas les enfants sans surveillance!
(GB) Do not leave children unattended!
(IT) Non lasciare bambini incustoditi!
(DE) Lassen Sie Kinder nicht unbeaufsichtigt!
(NL) Laat kinderen niet zonder toezicht!

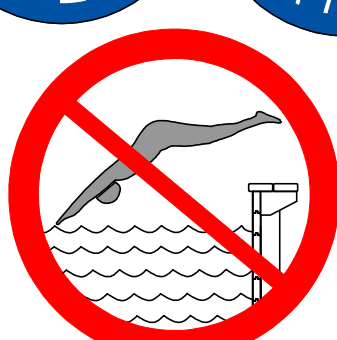

(PL) Elementy

(GB) Elements

(DE) Elemente

(FR) Les éléments

(IT) Elementi

(NL) Balken



(PL) Sprawdź ilość oraz czy elementy nie są uszkodzone.

(FR) Vérifiez la quantité et si les éléments ne sont pas abîmés.

(GB) Check quantity of elements and if they are not faulty.

(IT) Controllare la quantità e se gli elementi non sono danneggiati.

(DE) Überprüfen Sie die Menge, und ob die Elemente nicht beschädigt sind.

(NL) Controleer de aantal balken, en op eventuele beschadigingen.

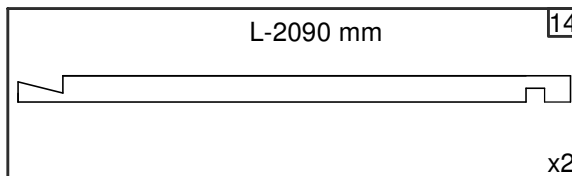
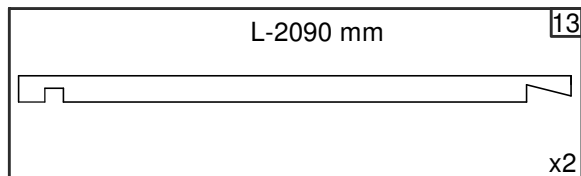
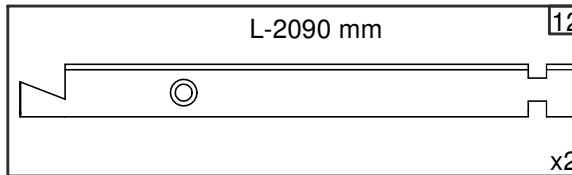
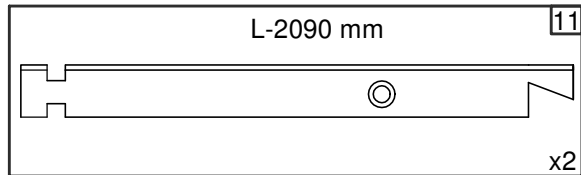
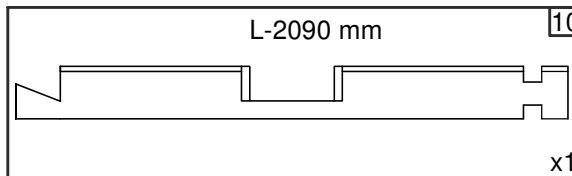
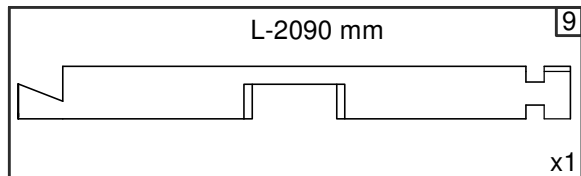
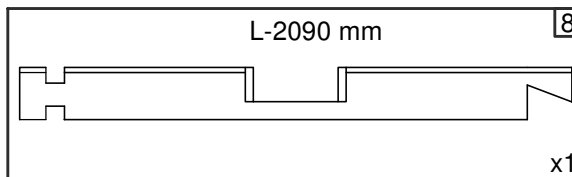
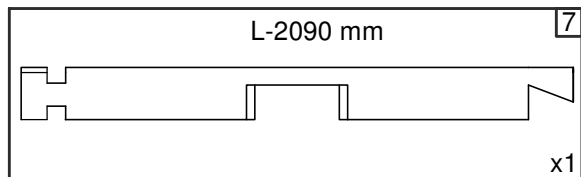
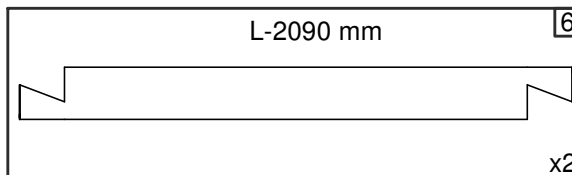
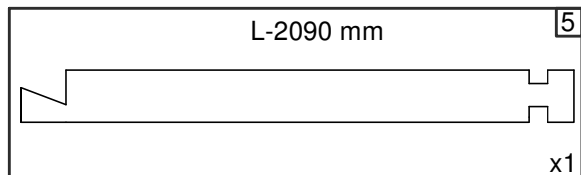
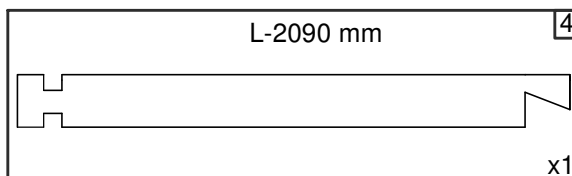
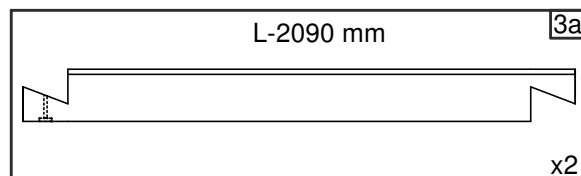
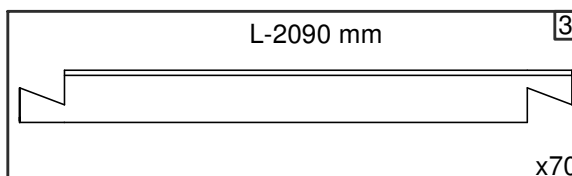
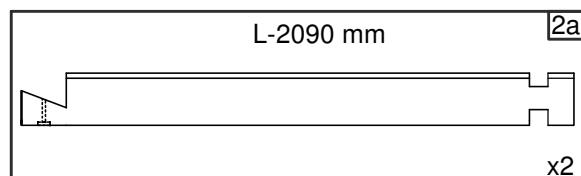
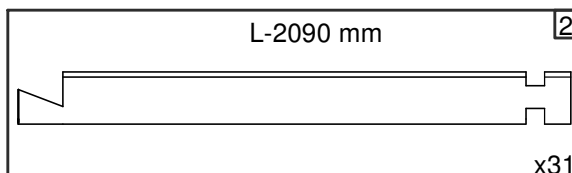
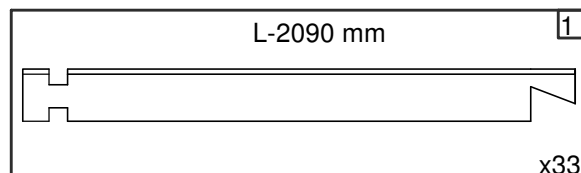
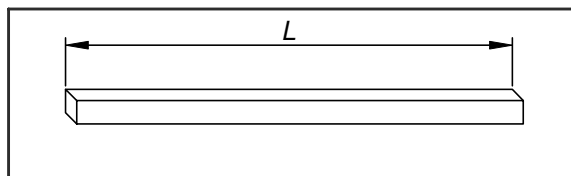

(PL) Elementy

(GB) Elements

(DE) Elemente

(FR) Les éléments

(IT) Elementi

(NL) Balken



(PL) Sprawdź ilość oraz czy elementy nie są uszkodzone.

(FR) Vérifiez la quantité et si les éléments ne sont pas abîmés.

(GB) Check quantity of elements and if they are not faulty.

(IT) Controllare la quantità e se gli elementi non sono danneggiati.

(DE) Überprüfen Sie die Menge, und ob die Elemente nicht beschädigt sind.

(NL) Controleer de aantal balken, en op eventuele beschadigingen.

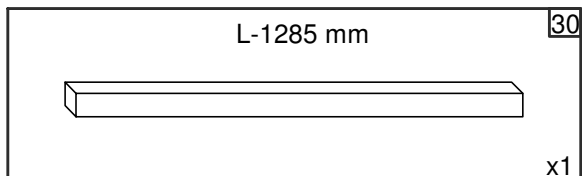
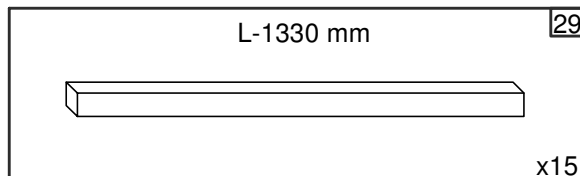
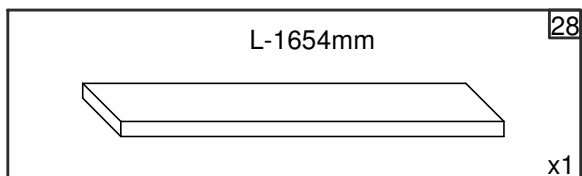
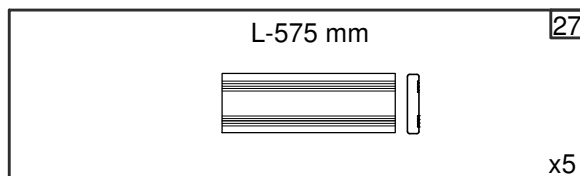
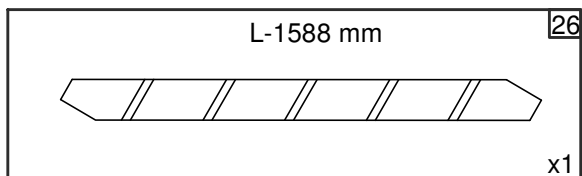
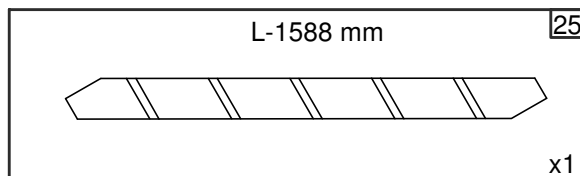
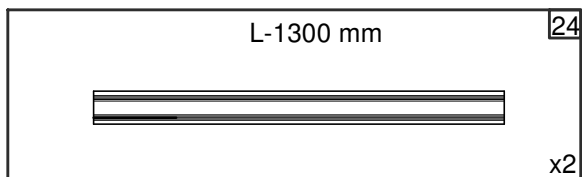
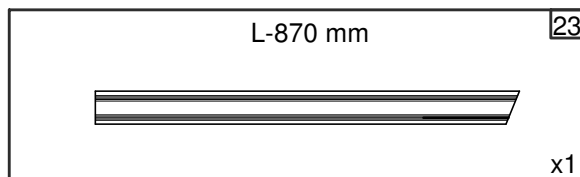
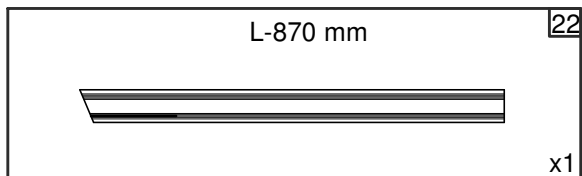
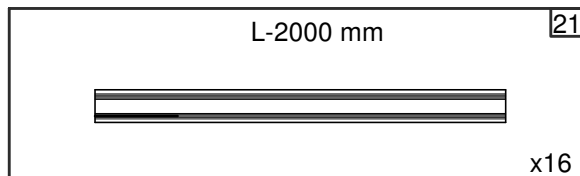
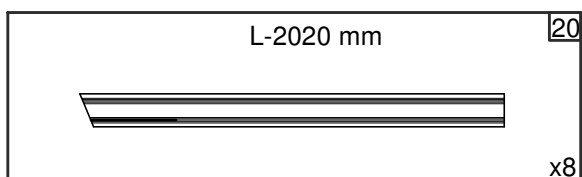
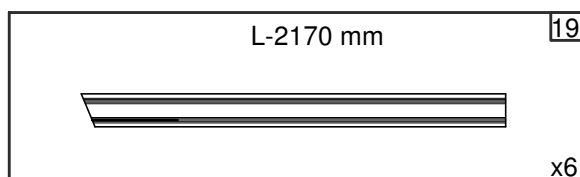
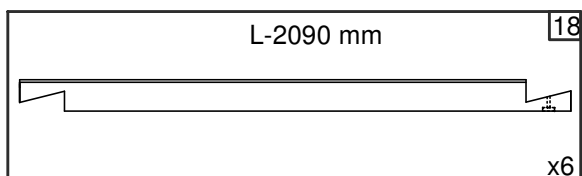
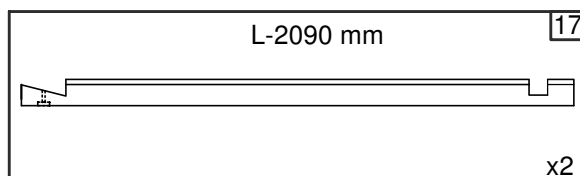
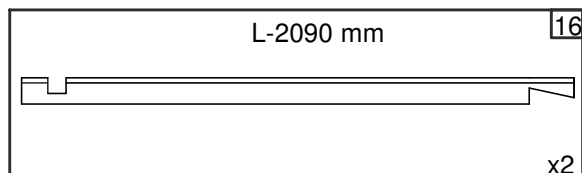
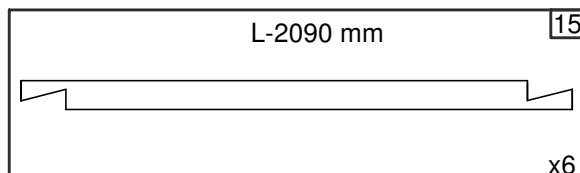
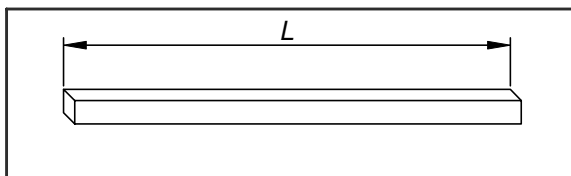

(PL) Elementy

(GB) Elements

(DE) Elemente

(FR) Les éléments

(IT) Elementi

(NL) Balken



- (PL)** Sprawdź ilość oraz czy elementy nie są uszkodzone.
- (FR)** Vérifiez la quantité et si les éléments ne sont pas abîmés.
- (GB)** Check quantity of elements and if they are not faulty.
- (IT)** Controllare la quantità e se gli elementi non sono danneggiati.
- (DE)** Überprüfen Sie die Menge, und ob die Elemente nicht beschädigt sind.
- (NL)** Controleer de aantal balken, en op eventuele beschadigingen.

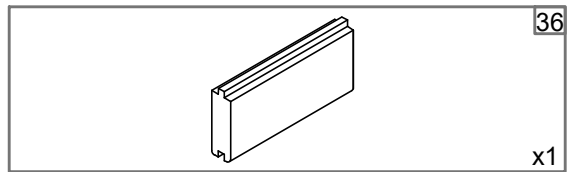
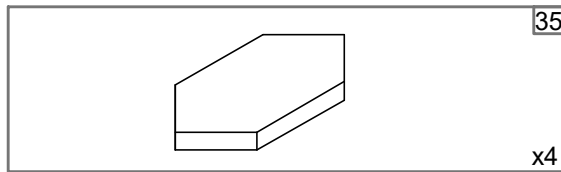
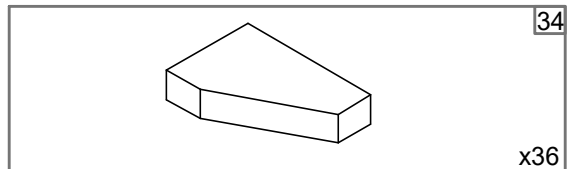
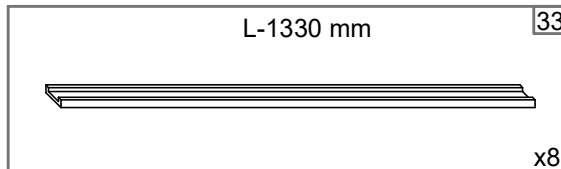
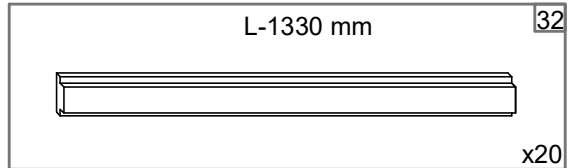
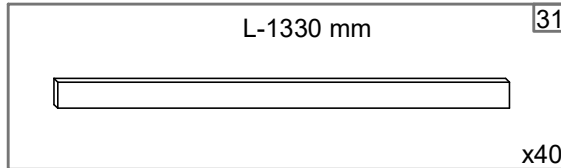
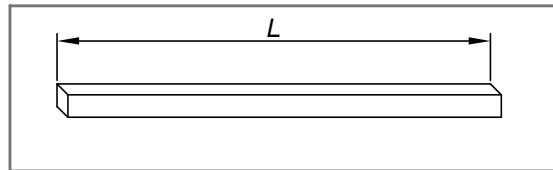

PL Okucia i osprzęt

GB Fittings and equipment

D Beschläge und Ausrüstung

FR Quincaillerie et l'équipement

IT Ferramenti e accessori

NL Bouwmaterialen



PL Sprawdź ilość.

FR Vérifiez la quantité.

GB Check quantity.

IT Controllare la quantità

D Überprüfen Sie die Menge.

NL Controleer het aantal.

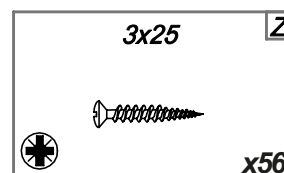
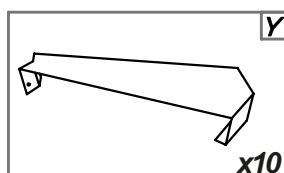
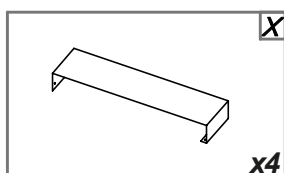
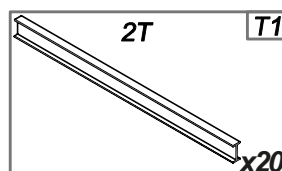
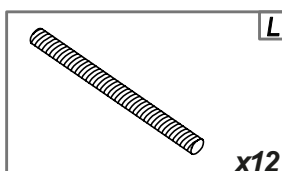
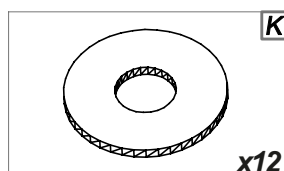
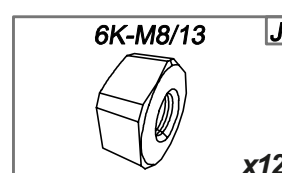
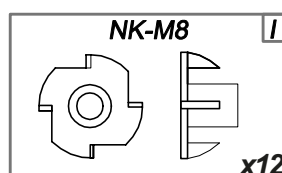
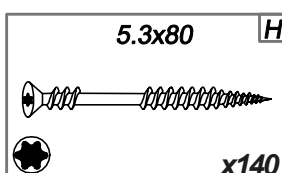
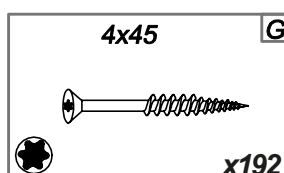
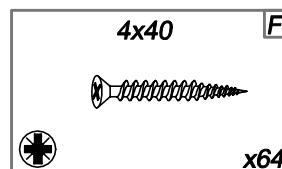
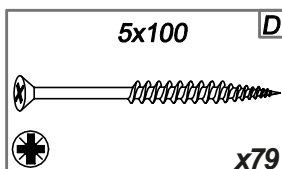
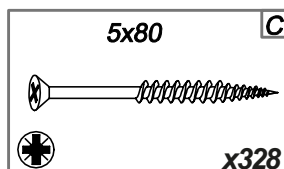
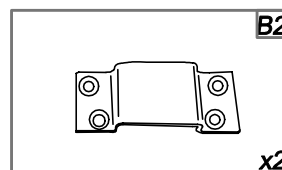
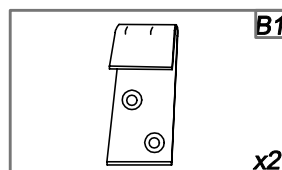

(PL) Narzędzia

(GB) Tools

(DE) Werkzeuge

(FR) Les outils

(IT) Strumenti

(NL) Gereedschap

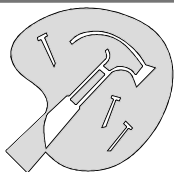

(PL) Przygotuj niezbędne narzędzia - niezawarte w zestawie.

(FR) Préparez les outils nécessaires - pas inclus.

(GB) Prepare essential tools- not included.

(IT) Preparare gli strumenti necessari - non inclusi nel set.

(DE) Bereiten Sie notwendiges, nicht im Satz enthaltenes Werkzeug vor.

(NL) Benodigd gereedschap - niet inbegrepen.

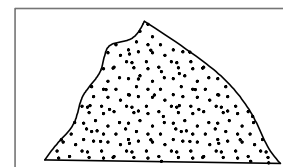
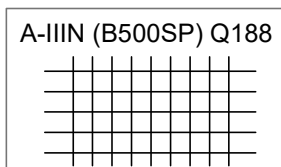
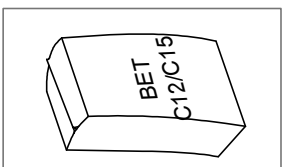
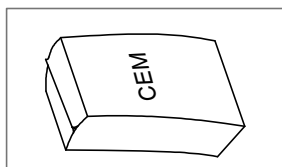
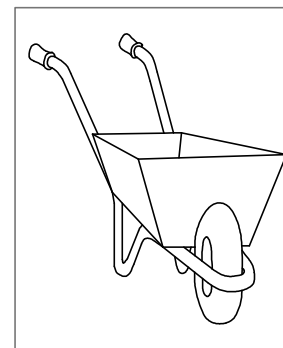
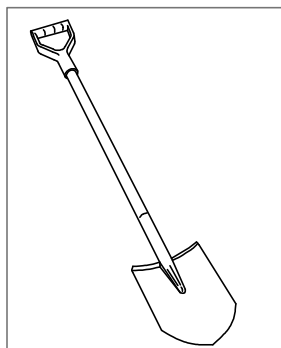
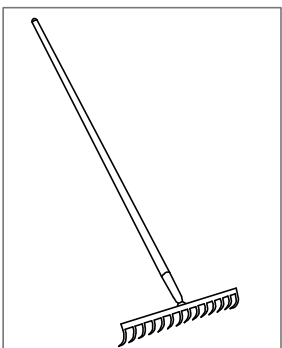
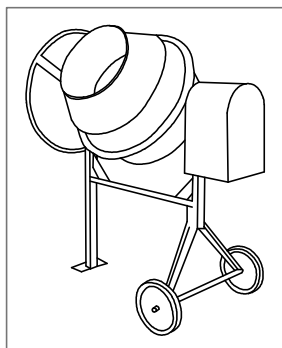
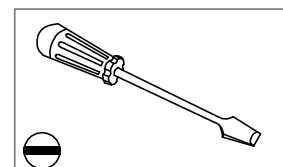
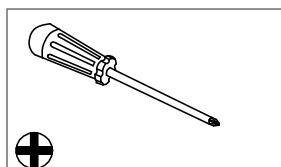
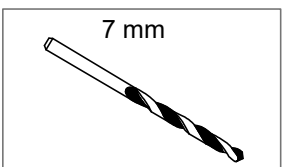
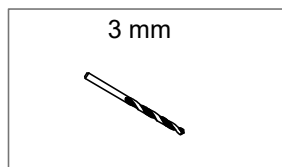
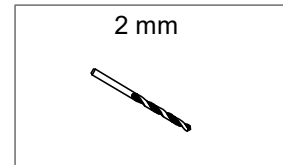
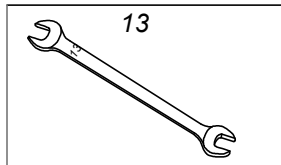
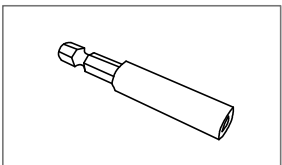
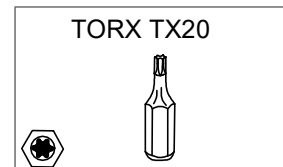
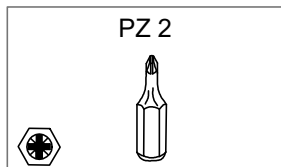
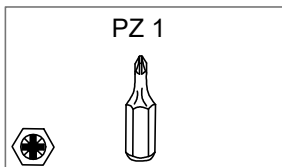
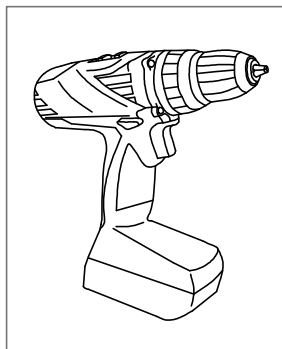
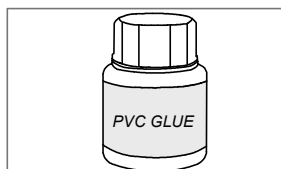
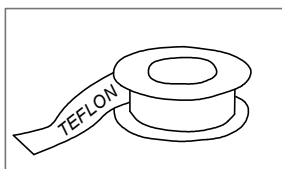
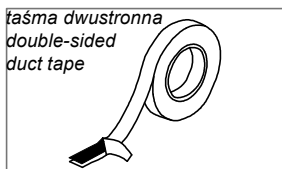
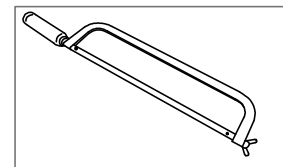
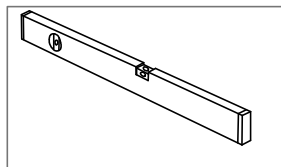
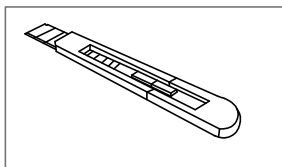
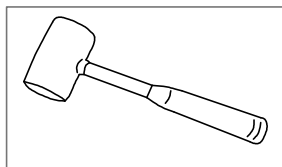
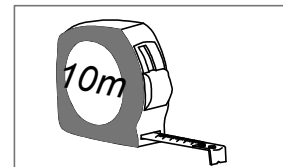
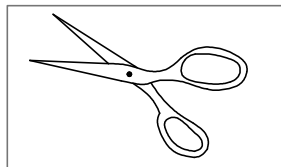
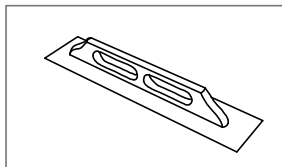
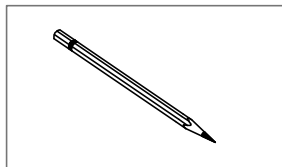

(PL) Podłoże

(GB) Ground

(DE) Untergrund

(FR) Terrain

(IT) Suolo

(NL) Ondergrond



- (PL) Struktura basenu wkopanego musi być zabezpieczona zgodnie z dołączoną dodatkowo dokumentacją.
(FR) Il est exigé que la structure de la piscine enterrée soit convenablement protégée selon les indices dans le document supplémentaire ci-joint.
(GB) Structure of in-ground pool must be secured in accordance with additional enclosed documentation.
(IT) È esatto che la struttura della piscina seppellita sia protetta correttamente in allegato secondo gli indizi nel documento supplementare.
(DE) Die Struktur des Pools, der ausgegraben wird, muss gesichert werden, gemäß information in der Begleitdokumentation.
(NL) De constructie van het ingebouwde zwembad moet beschermd worden volgens de instructies in bijgaande documentatie.

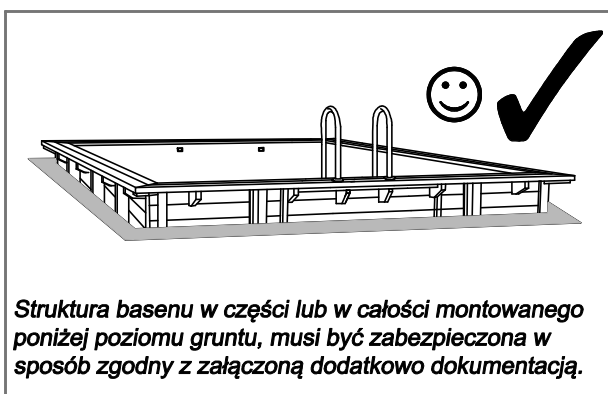
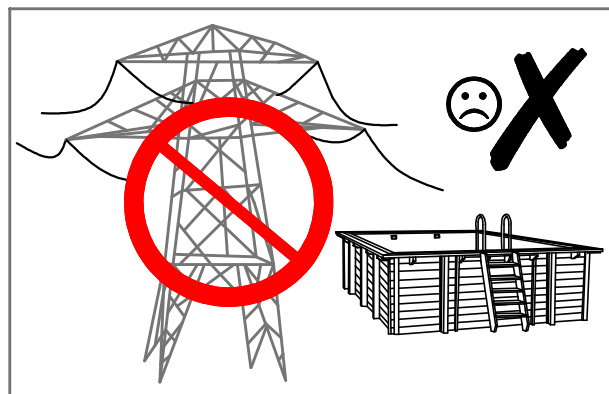
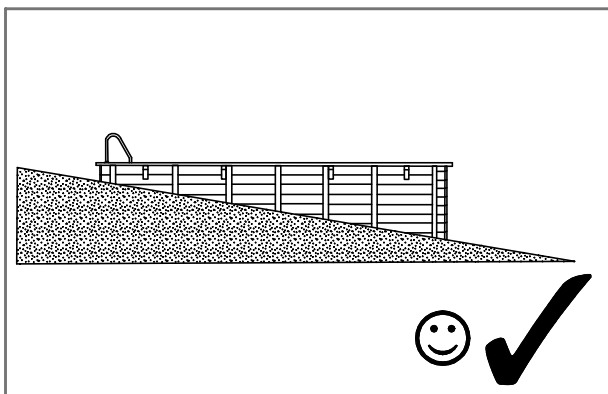
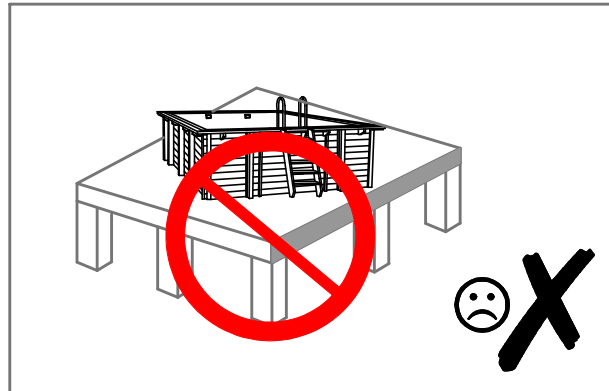
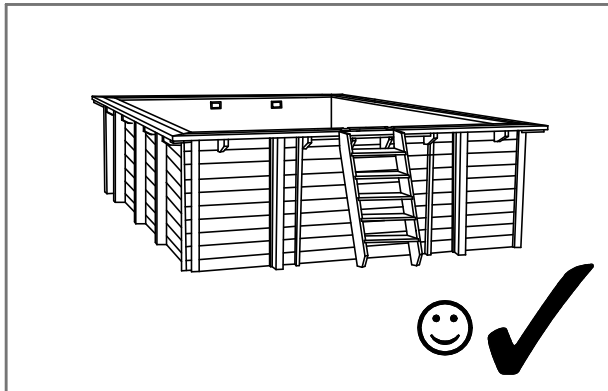

(PL)

Struktura basenu w części lub w całości montowanego poniżej poziomu gruntu, musi być zabezpieczona w sposób zgodny z załączoną dodatkowo dokumentacją.

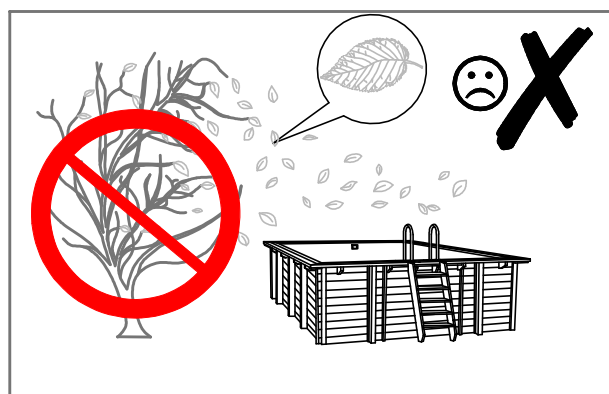

Il est exigé que la structure de la piscine enterrée ou

(FR)

semi-enterrée soit convenablement protégée selon les indices dans le document supplémentaire ci-joint.

(GB)

Structure of partly or fully in-ground pool, must be secured in accordance with additional enclosed documentation.

(IT)

È esatto che la struttura della piscina sepolta o semi-sepolta sia protetta correttamente in allegato secondo gli indizi nel documento supplementare.

(DE)

Die Struktur des Pools, die teilweise oder vollständig unter der Erdoberfläche montiert ist, muss gemäß der beiliegenden Dokumentation gesichert werden.

(NL)

De constructie van het half- of volledig ingebouwde zwembad moet beschermd worden volgens de instructies in bijgaande documentatie.

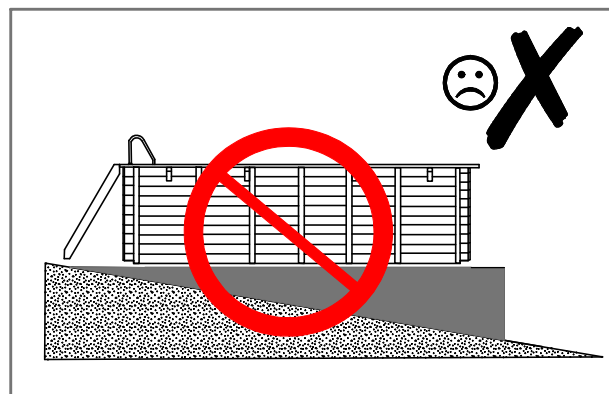

(PL) Podłoże

(GB) Ground

(DE) Untergrund

(FR) Terrain

(IT) Suolo

(NL) Ondergrond



- (PL)** Wymagane zabezpieczenie struktury przy montażu basenu poniżej poziomu gruntu.
(FR) La protection de la structure dans le cas de la piscine totalement ou partiellement enterrée.
(GB) Wooden structure protection required in case of in-ground installation.
(IT) La protezione della struttura nel caso della piscina totalmente o parzialmente sepolta.
(DE) Erforderliches Schutz für Struktur eines Holzpool, wenn es unter der Boden montieren.
(NL) Bescherming van de houten constructie is absoluut noodzakelijk bij ingebouwde zwembaden.

- 1** FUNDAMENT BASENU / DALLE BETON / FOUNDATION / LASTRA CEMENTO / DAS FUNDAMENT / FUNDERING
- 2** RURA DRENARSKA / TUYAU DE DRAINAGE / DRAINAGE PIPE / TUBO DI DRENAGGIO / DIE DRAINAGEROH / AFVOERPIJP
- 3** PEÇHERZYKOWA FOLIA FUNDAMENTOWA / PROTECTION DE SOUBASSEMENT / FOINDATION BUBBLE WRAP / FONDALINE / DAS FUNDAMENT NOPPENFOLIE / BOUWFOLIE
- 4** ŻWIR / GRAVIER / GRAVEL / GHIAIA / DER KIES / GRAVEL
- 5** GEOWŁÓKNINA OGRODOWA / GEOTEXTILE / GEOTEXTILE / GEOTESSILI / GARTEN GEOTEXTILE / GEOTEXTEL
- 6** GRUNT / TERRAIN / GROUND / TERRENO / DER BODEN / BODEM

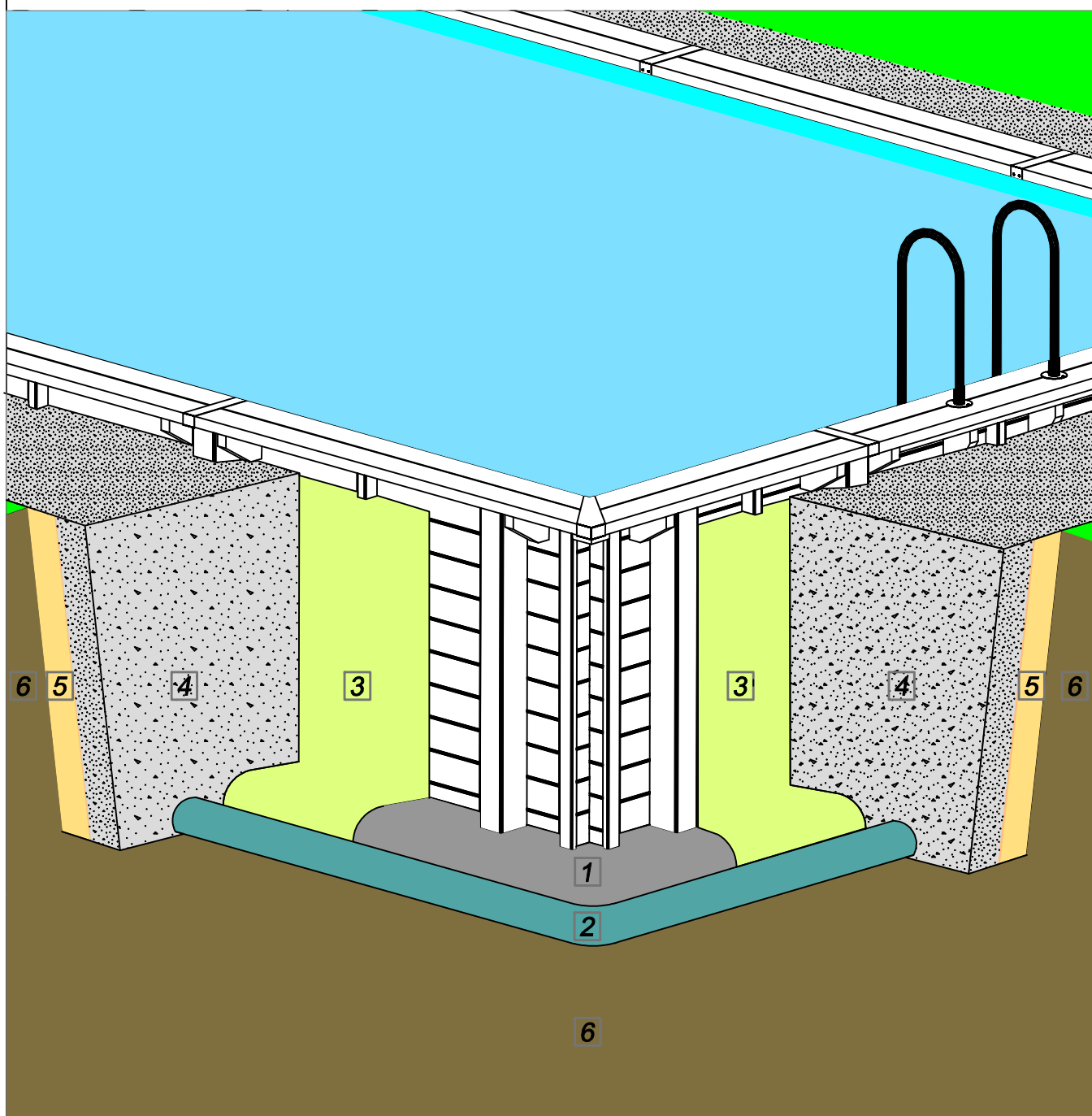

(PL) Podłoże

(GB) Ground

(DE) Untergrund

(FR) Terrain

(IT) Suolo

(NL) Ondergrond



(PL) Schemat przygotowania wykopu / podłoża pod zbrojoną wylewkę betonową.

(FR) Schema de préparation de l'excavation / du terrain pour la dalle en béton armé.

(GB) Diagram of preparation of trench / subfloor for reinforced concrete screed.

(IT) Schema per la preparazione degli scavi / substrato ricoperto da cemento armato.

(DE) Schema der Vorbereitung der Ausschachtung / Untergrund für den bewehrten Betonestrich.

(NL) Schema voor de voorbereiding van de sleuf / ondergrond voor de dekvloer uit gewapend beton.

[mm]

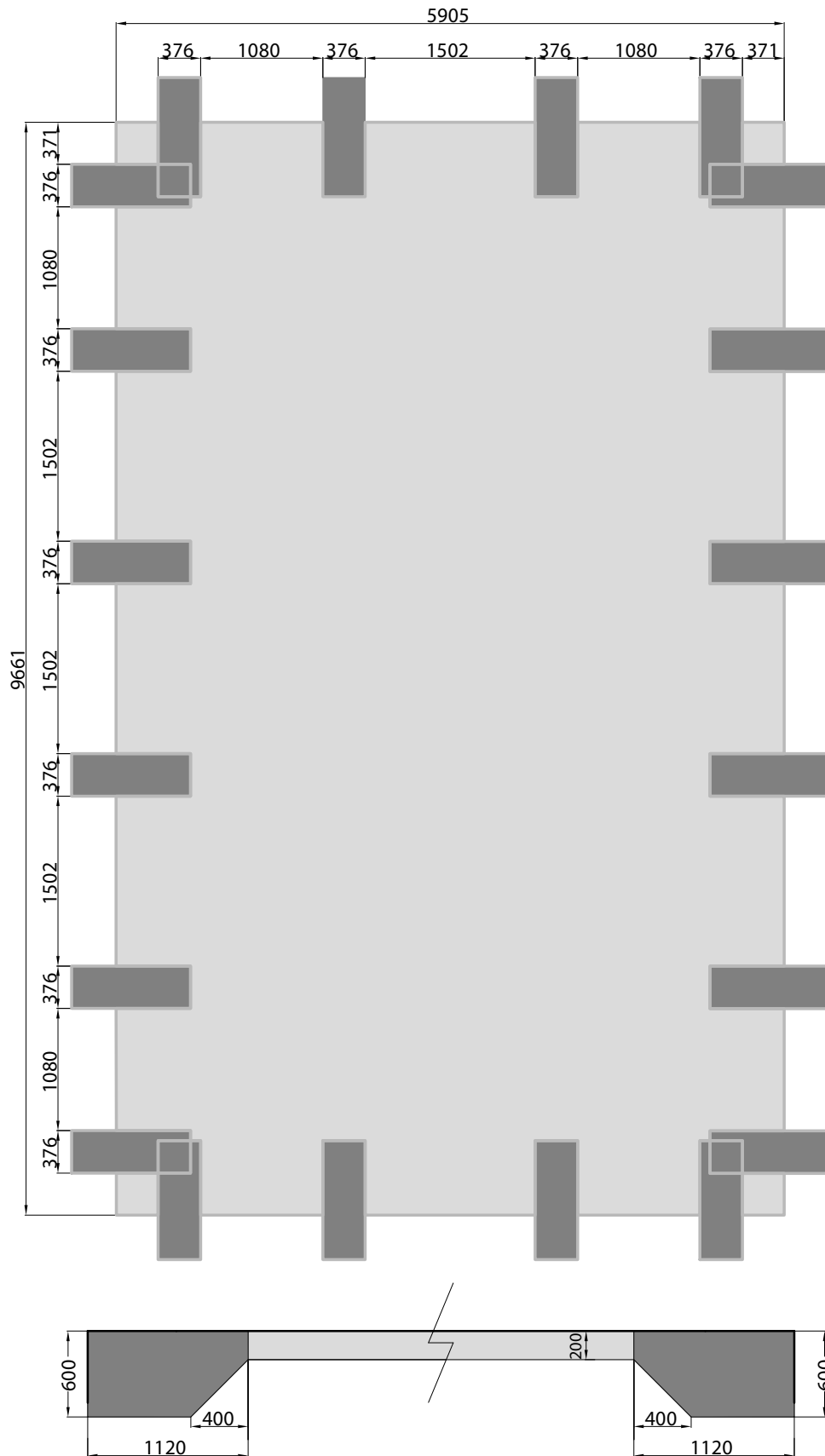

N.B. Soluzione non applicabile a un sistema autoportante. (Vedere pagine 44-45)

(PL) Podłoże

(GB) Ground

(DE) Untergrund

(FR) Terrain

(IT) Suolo

(NL) Ondergrond



(PL) Powierzchnia musi być twarda, płaska i wypoziomowana. Zastosuj piasek stabilizowany cementem.

(FR) Le terrain doit être rigoureusement plat, dur et de niveau. Utilisez le sable stabilisé au ciment.

(GB) The surface must be firm, flat and leveled. Use cement-stabilized sand.

(IT) La superficie deve essere solida, piana e livellata. Utilizzare sabbia stabilizzata con cemento.

(DE) Der Untergrund muss fest, eben und nivelliert sein. Verwenden Sie zementstabilisierten Sand.

(NL) De ondergrond moet stevig, vlak en genivelleerd zijn. Gebruik gestabiliseerd zandcement.

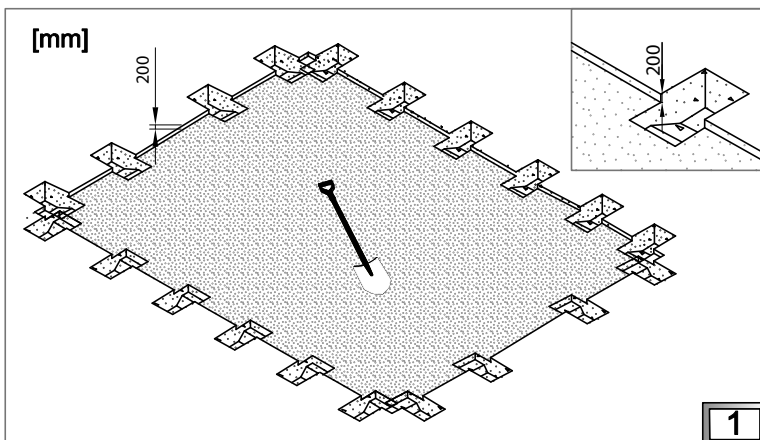
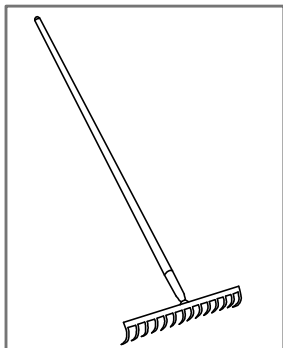
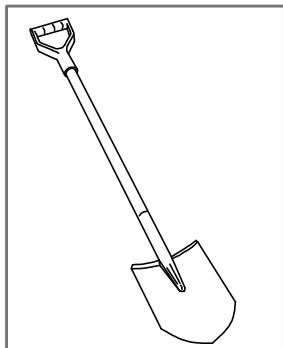

1

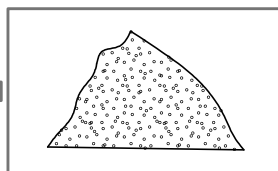
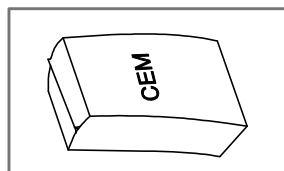
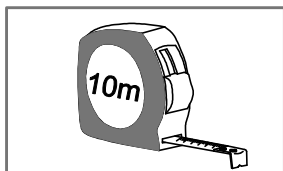

N.B. Soluzione non applicabile a un sistema autoportante. (Vedere pagine 44-45)

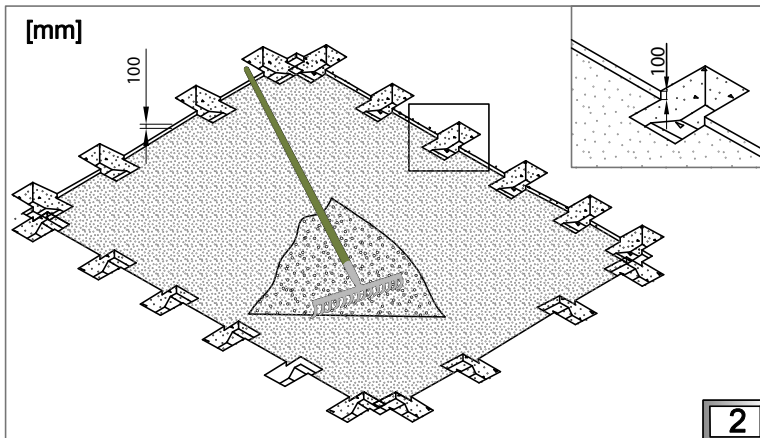
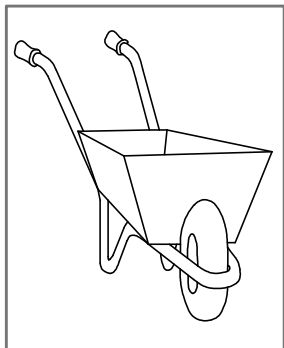
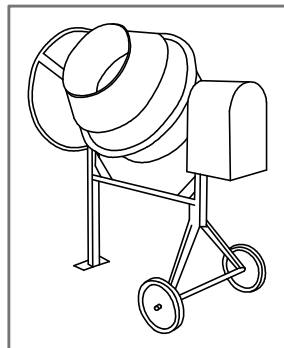

2

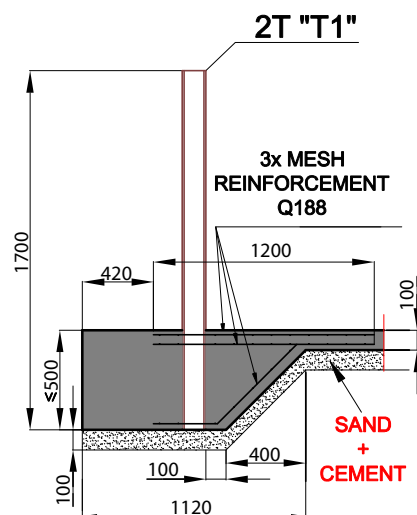
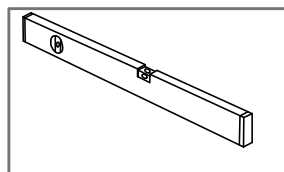
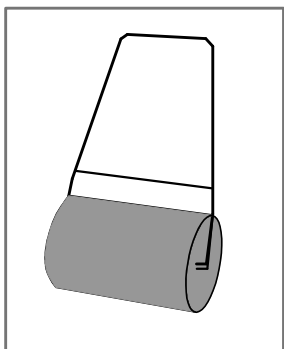
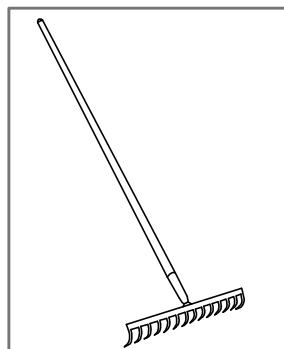

PL Podłóże

GB Ground

DE Untergrund

FR Terrain

IT Suolo

NL Ondergrond



PL Schemat rozmieszczenia słupków 2T (T1) oraz przygotowania zbrojenia pod wylewkę betonową.

FR Schema de positionnement des poteaux 2T (T1) et préparation de l'armature pour la dalle en béton.

GB Diagram of arrangement of posts 2T (T1) and preparation of reinforcment for concrete screed.

IT Schema per la spartizione dei pali 2T (T1) e per la preparazione dell'armatura sotto il calcestrutto.

DE Schema der Platzierung von Baupfosten 2T (T1) und Vorbereitung der Bewehrung für den Betonestrich.

NL Schema voor de plaatsing 2T (T1) van de palen en voorbereiding van de wapening voor de betonnen dekvloer.

[mm]

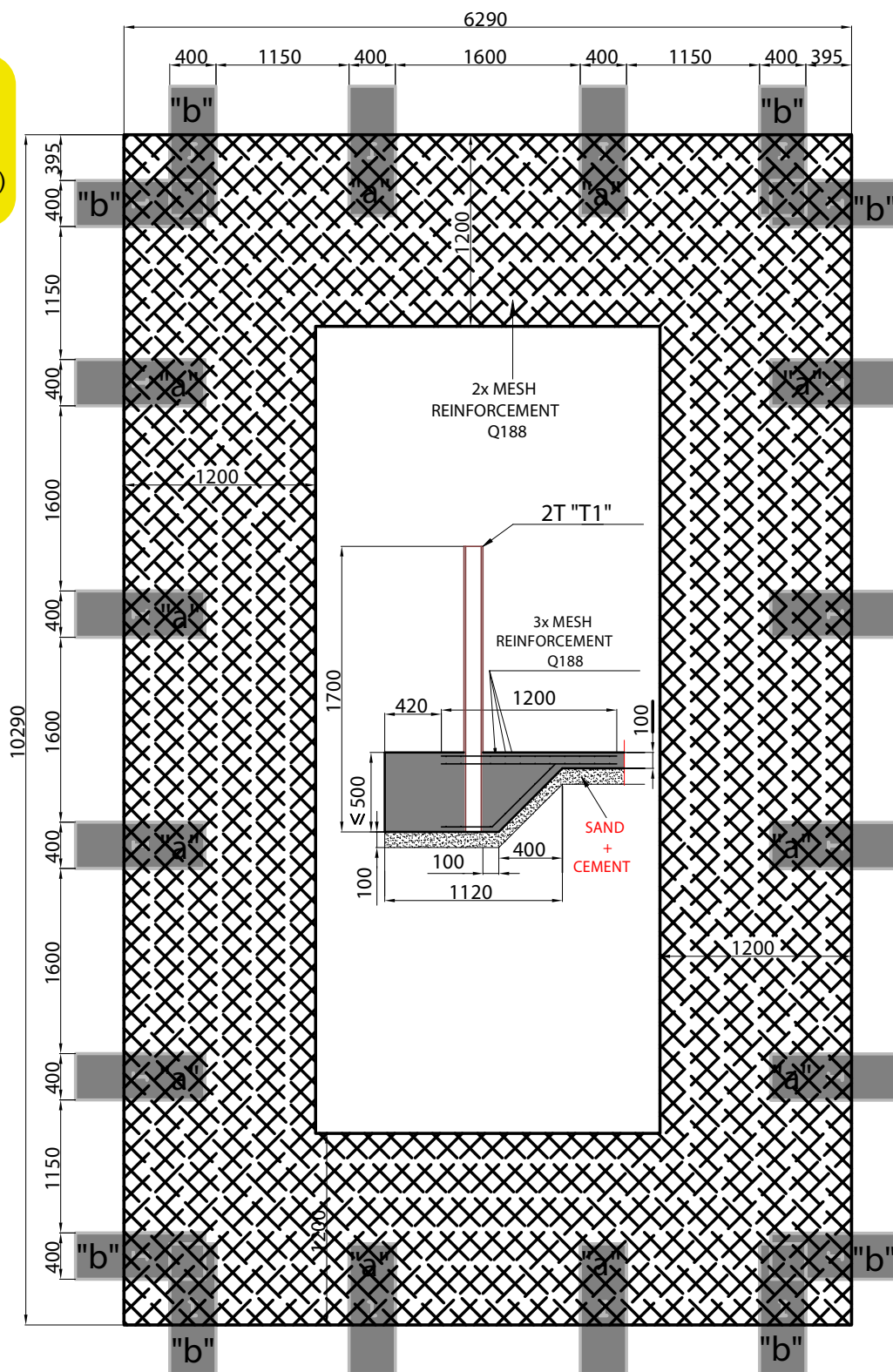

N.B. Soluzione non applicabile a un sistema autoportante. (Vedere pagine 44-45)

(PL) Podłoże

(GB) Ground

(DE) Untergrund

(FR) Terrain

(IT) Suolo

(NL) Ondergrond



(PL) Powierzchnia musi być twarda, płaska i wypoziomowana. Pamiętaj o wykonaniu zbrojenia wylewki betonowej.
(FR) Le terrain doit être rigoureusement plat, dur et de niveau. Préparez l'armature de la dalle en béton.
(GB) The surface must be firm, flat and leveled. Remember about reinforcement of concrete screed.
(IT) La superficie deve essere solida, piana e livellata. Ricardati di eseguire l'armatura per il calcestruzzo.
(DE) Der Untergrund muss fest, flach und eben sein. Vergessen Sie nicht den Betonestrich zu bewehren.
(NL) De ondergrond moet stevig, vlak en genivelleerd zijn. Vergeet niet de wapening van de betonnen dekvloer te maken.

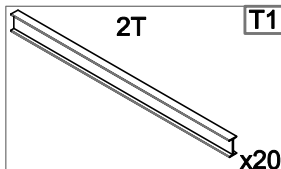
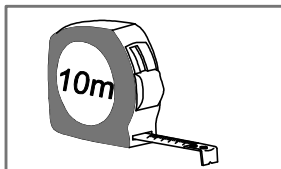
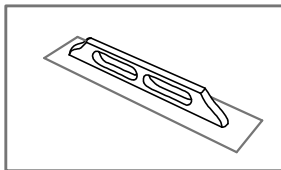
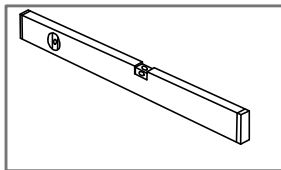
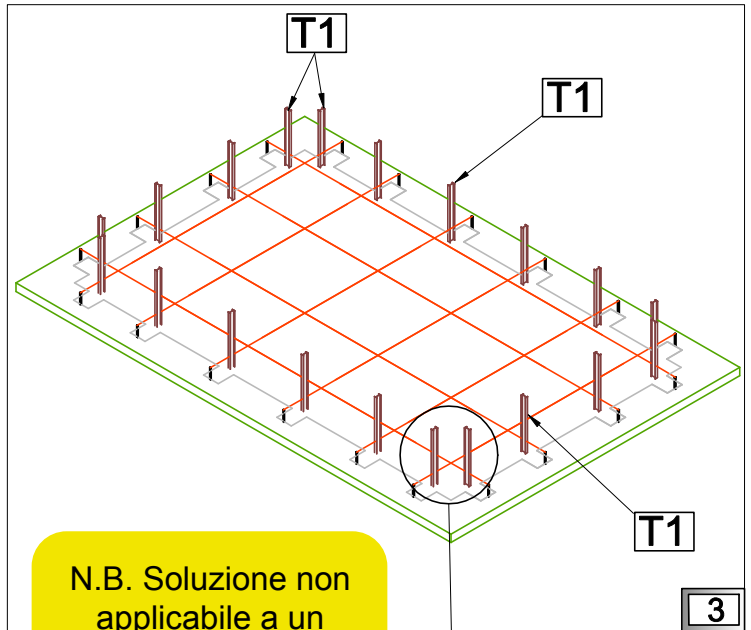
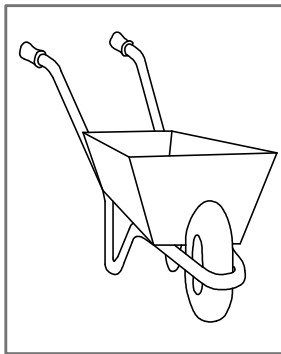
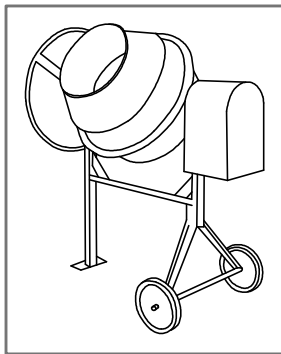
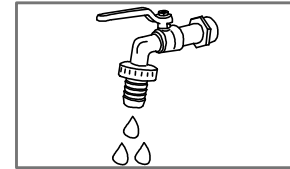
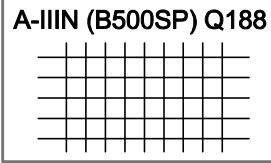
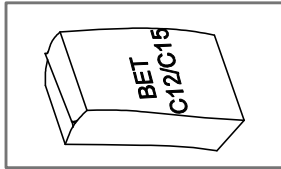

N.B. Soluzione non applicabile a un sistema autoportante. (Vedere pagine 44-45)

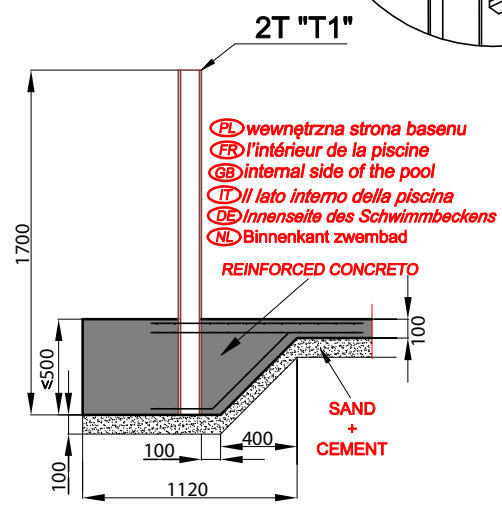
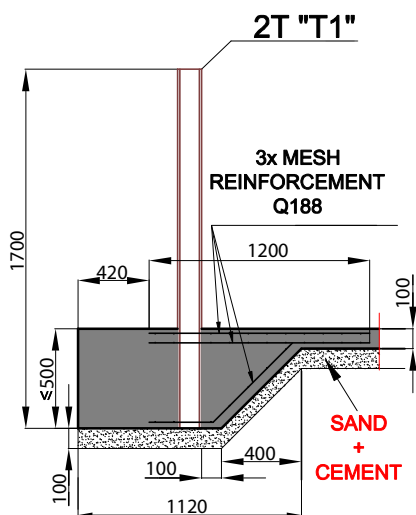
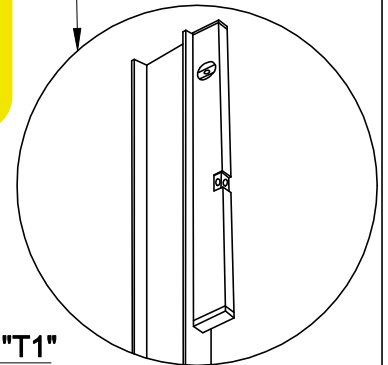

(PL) wewnętrzna strona basenu
(FR) l'intérieur de la piscine
(GB) internal side of the pool
(IT) Il lato interno della piscina
(DE) Innenseite des Schwimmbeckens
(NL) Binnenkant zwembad

PL Podłóże

GB Ground

DE Untergrund

FR Terrain

IT Suolo

NL Ondergrond



- PL Schemat rozmieszczenia słupków 2T (T1) oraz przygotowania wylewki betonowej.
- FR Le schéma de la disposition des poteaux métalliques 2T (T1) et de la préparation de la dalle en béton.
- GB Scheme of steel bearers 2T (T1) arrangement, preparing concrete base.
- IT Schematica dei pilastri 2T (T1) e della preparazione di calcestruzzo.
- DE Das Schema der Anordnung von Pfählen 2T (T1) und Vorbereitung des Betonestruchs.
- NL Installatie van de stalen dragers 2T (T1) met betonnen voet.

[mm]

N.B. Soluzione non applicabile a un sistema autoportante. (Vedere pagine 44-45)

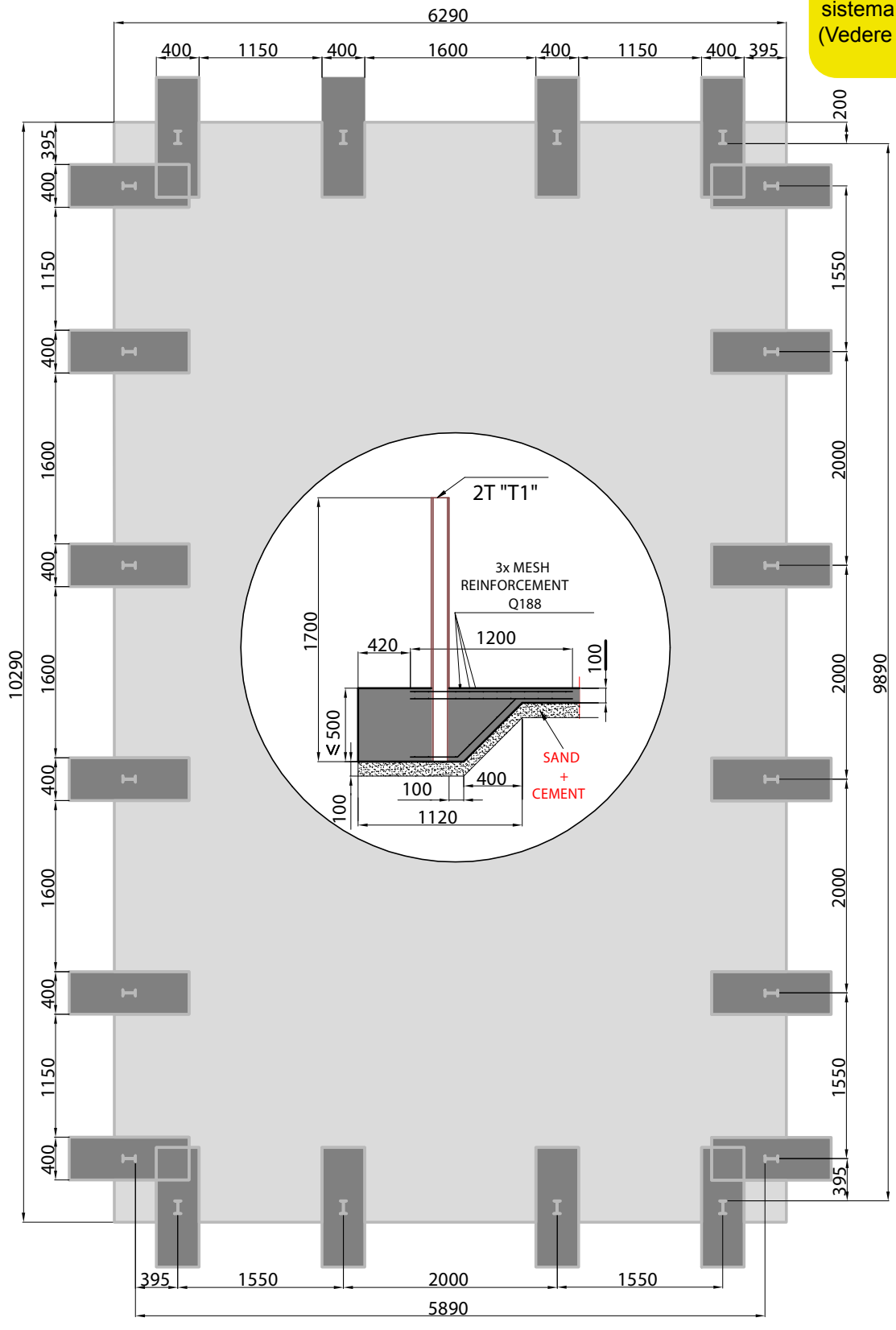

(PL) Struktura drewniana

(GB) Wooden structure

(DE) Holzstruktur

(FR) La structure bois

(IT) Struttura in legno

(NL) Houten structuur



(PL) Schemat rozmieszczenia warstw struktury. Ułożenie warstwy I.

(FR) Le schéma de la disposition des couches de la structure. La pose de la couche I.

(GB) Arrangement of structure's layers. Putting layer I.

(IT) Schematica degli strati della struttura. Posare lo strato I.

(DE) Schema der Anordnung von Strukturschichten. Auflegen der I-Schichte.

(NL) Begin met laag I van het houten structuur, zie overzicht.

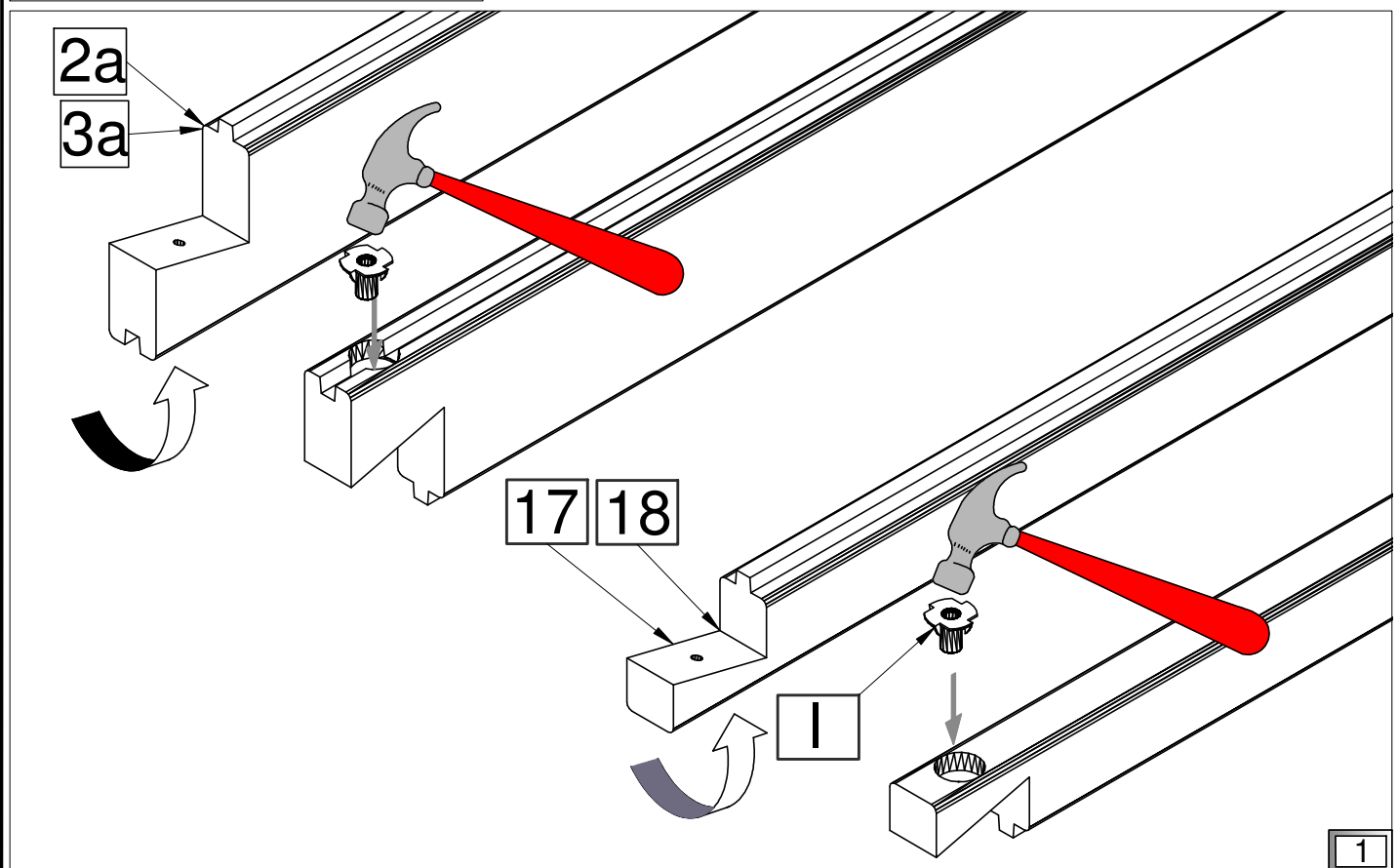
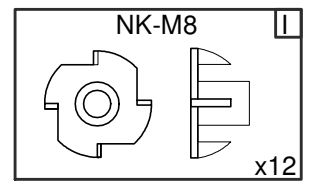
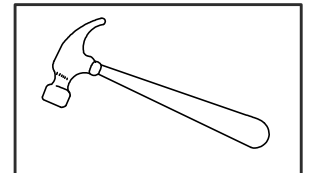
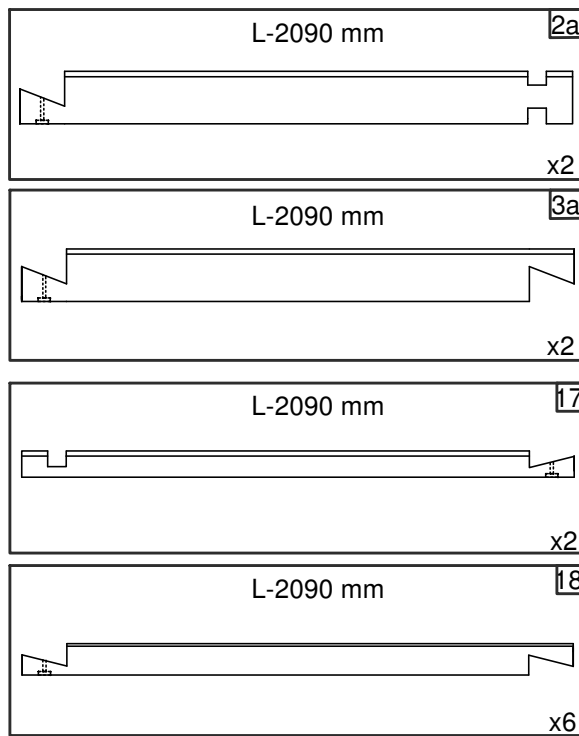
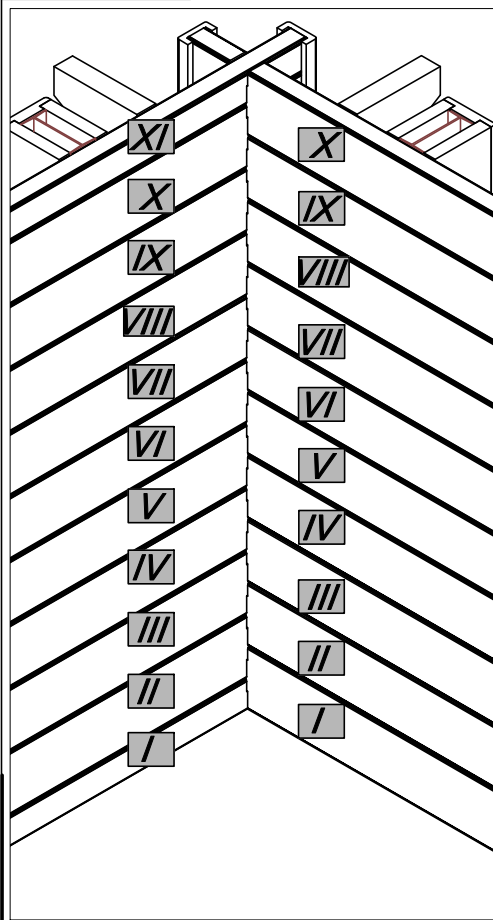

(PL) Struktura drewniana

(GB) Wooden structure

(DE) Holzstruktur

(FR) La structure bois

(IT) Struttura in legno

(NL) Houten structuur



(PL) Ułożenie warstwy I.

(FR) La pose de la couche I.

(GB) Putting layer I.

(IT) Posare lo strato I.

(DE) Auflegen der I-Schichte.

(NL) Begin met laag I van het houten structuur, zie overzicht.

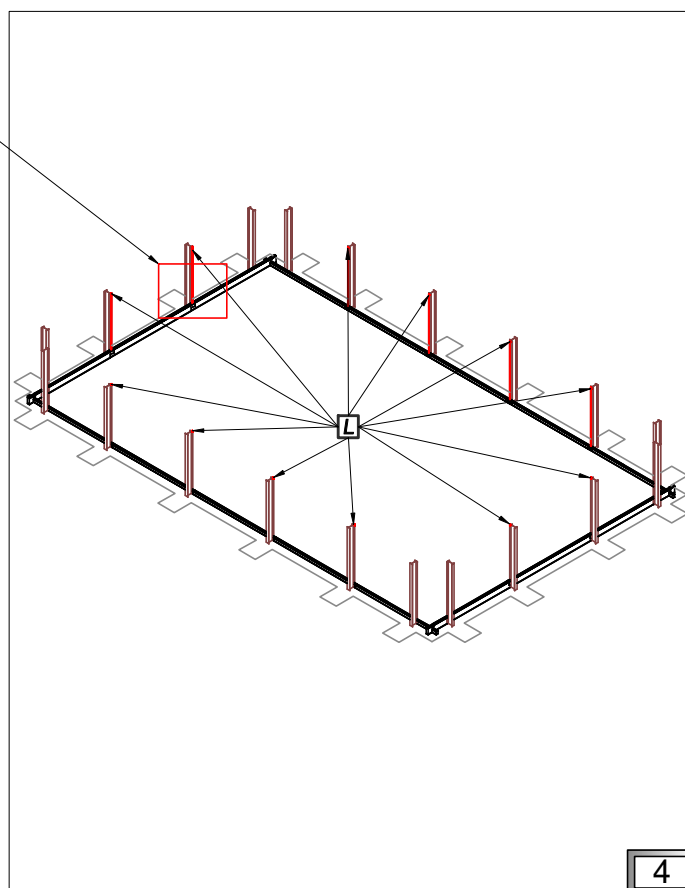
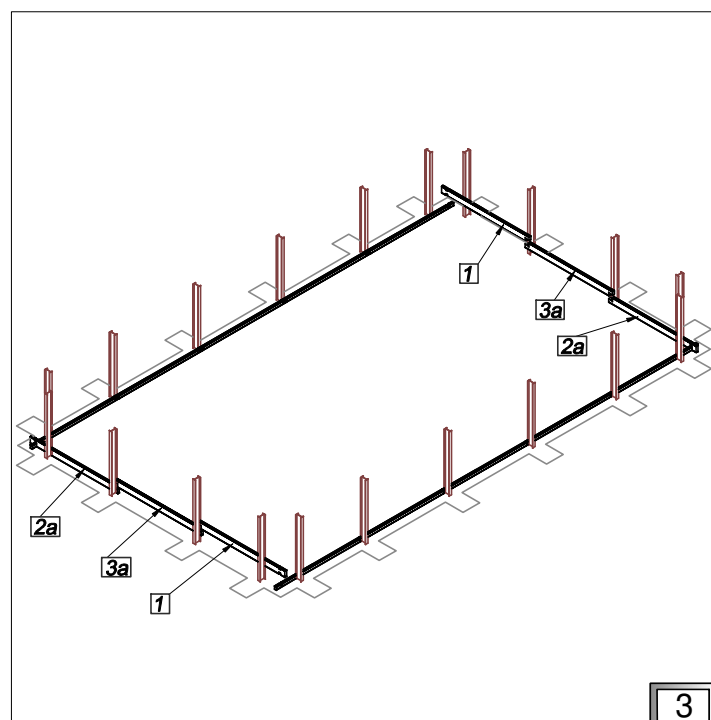
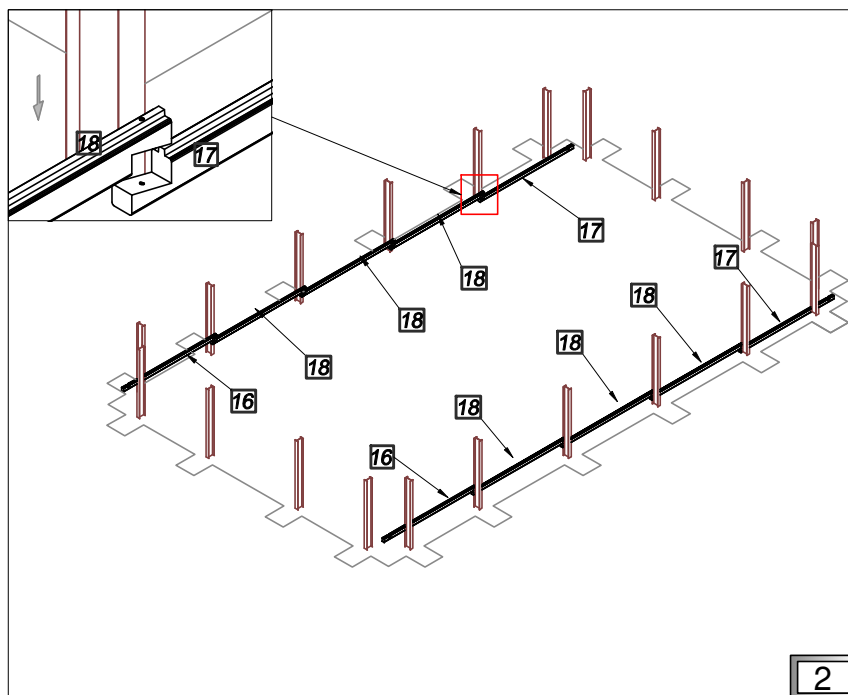
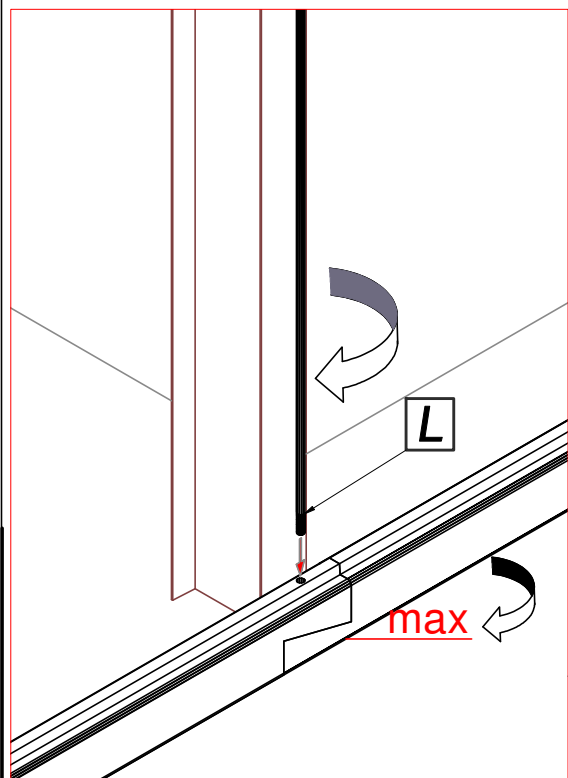
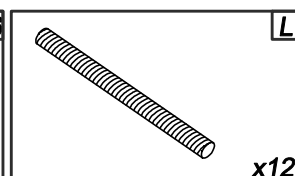
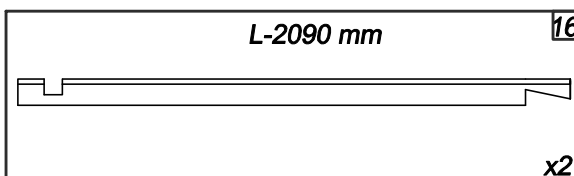
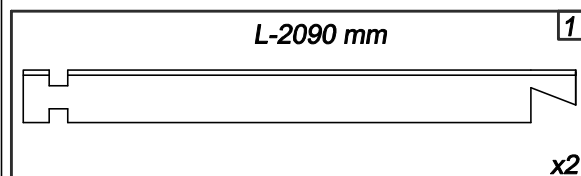

(PL) Struktura drewniana

(GB) Wooden structure

(DE) Holzstruktur

(FR) La structure bois

(IT) Struttura in legno

(NL) Houten structuur



(PL) Po ułożeniu każdej z warstw sprawdź przekątne D według rysunku.

(FR) Vérifiez les diagonales "D" après la pose de chaque tour.

(GB) After putting each layer check D diagonals according to the drawing.

(IT) Dopo la posa di ogni strato bisogna controllare diagonali D, secondo il disegno.

(DE) Nach Verlegen von jeder Schicht kontrollieren Sie D-Diagonale nach Schema.

(NL) Na het bouwen van de eerste laag controleer D diagonalen volgens de tekening.

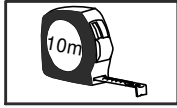

[mm]

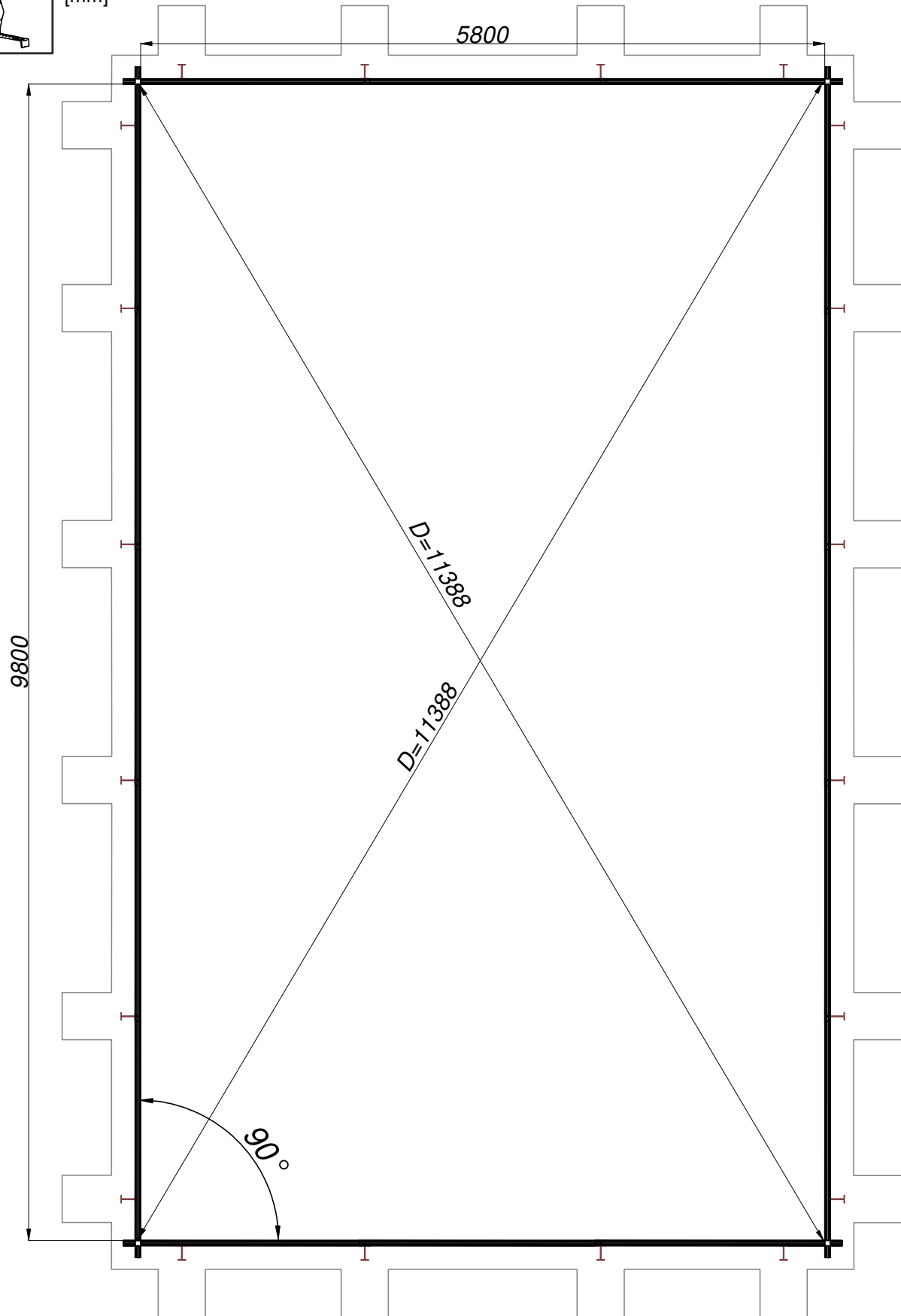

(PL) Struktura drewniana

(GB) Wooden structure

(DE) Holzstruktur

(FR) La structure bois

(IT) Struttura in legno

(NL) Houten structuur



(PL) Ułożenie kolejnych warstw. Sprawdzaj przekątną D po każdej ułożonej warstwie.

(FR) L'assemblage des couches suivantes. Vérifiez les diagonales "D" après la pose de chaque tour.

(GB) Putting next layers. Check D diagonals every layer.

(IT) La messa degli strati successivi. Trova la diagonale D dopo ogni strato.

(DE) Verlegen der nachfolgenden Schichten. Nach Verlegen von jeder Schicht kontrollieren Sie die D-Diagonale.

(NL) Installeer de volgende lagen en controleer diagonaal D.

11-111

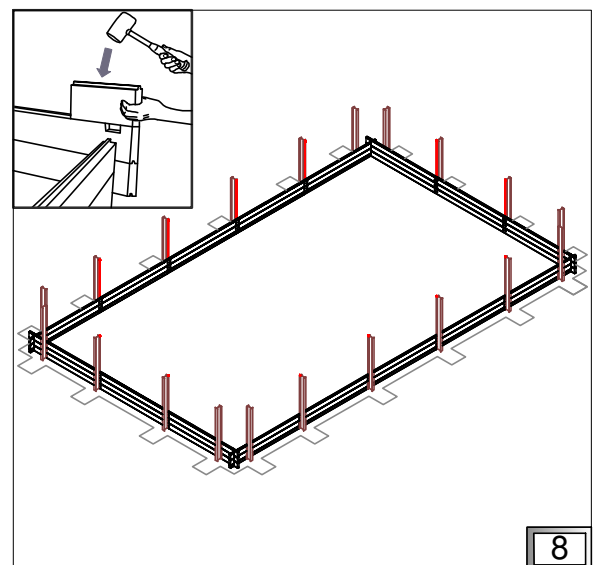
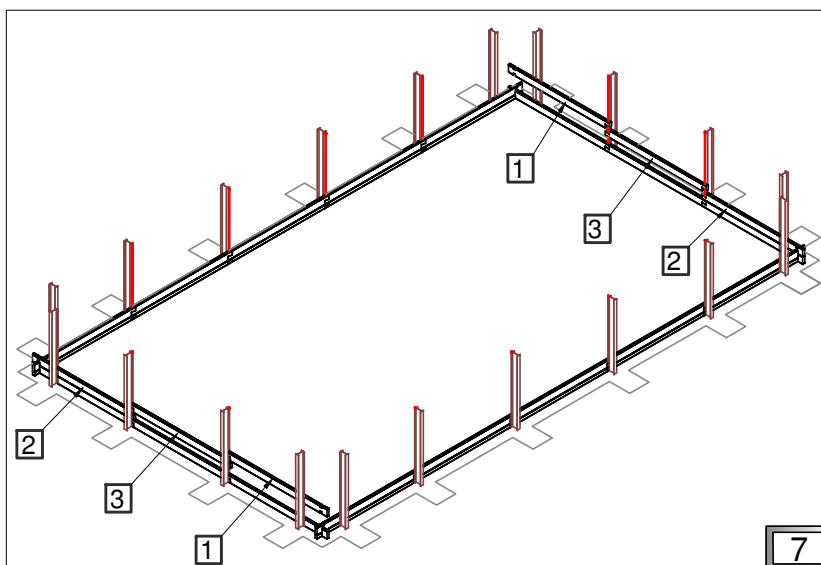
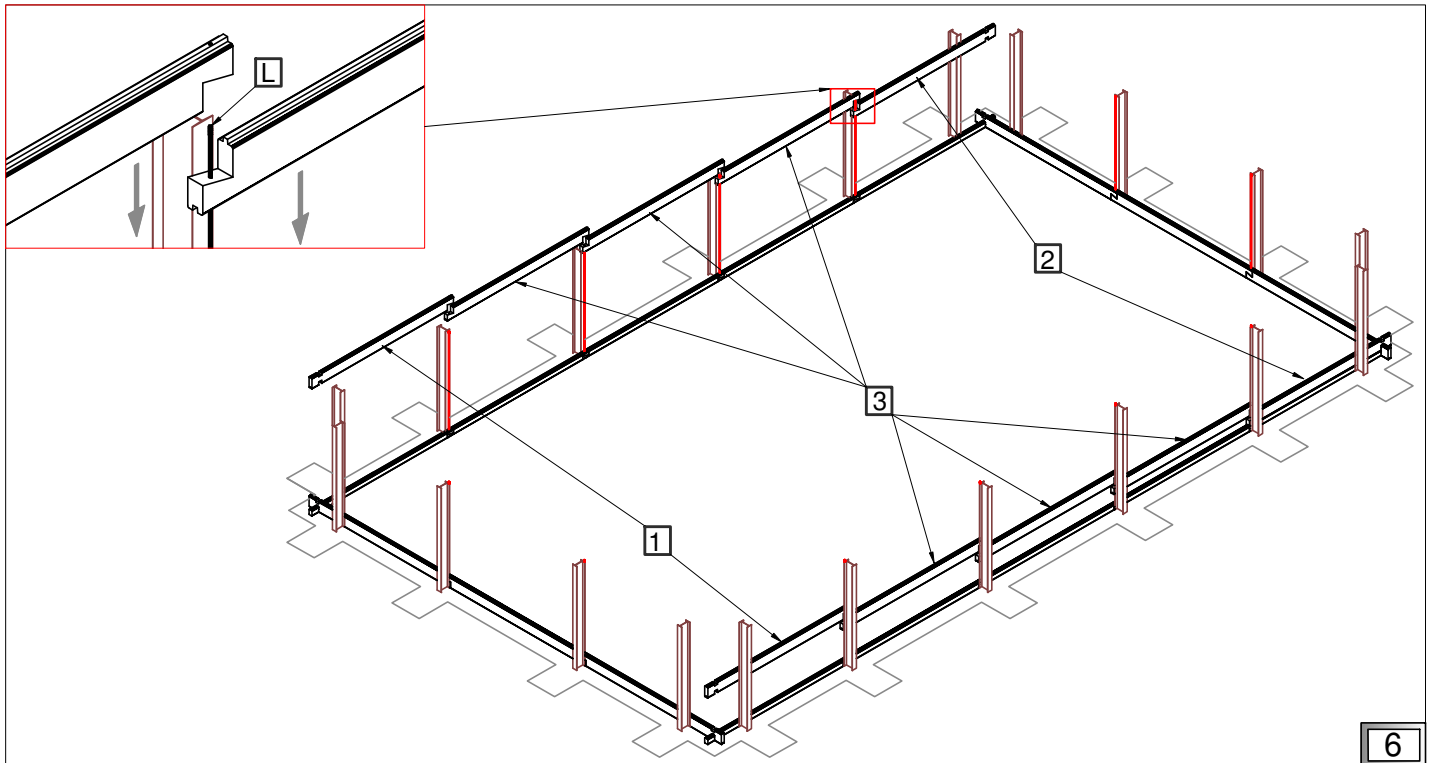
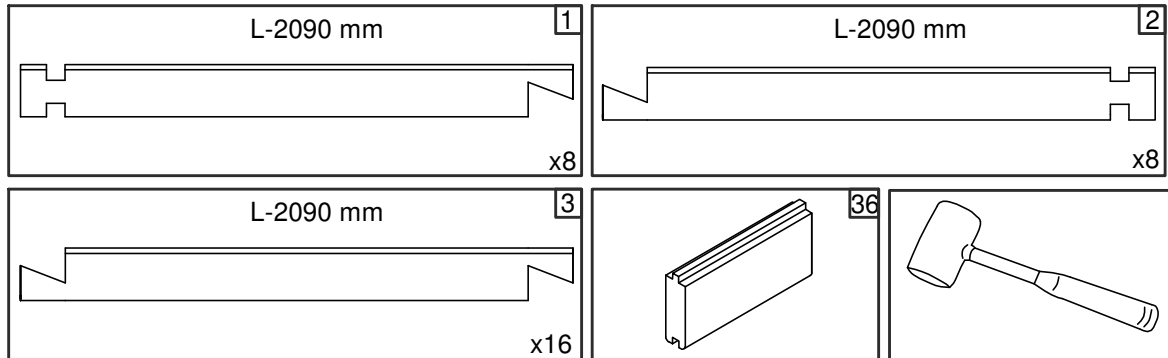

(PL) Struktura drewniana

(GB) Wooden structure

(DE) Holzstruktur

(FR) La structure bois

(IT) Struttura in legno

(NL) Houten structuur



(PL) Ułożenie kolejnych warstw. Sprawdzaj przekątną D po każdej ułożonej warstwie.

(FR) L'assemblage des couches suivantes. Vérifiez les diagonales "D" après la pose de chaque tour.

(GB) Putting next layers. Check D diagonals every layer.

(IT) La messa degli strati successivi. Trova la diagonale D dopo ogni strato.

(DE) Verlegen der nachfolgenden Schichten. Nach Verlegen von jeder Schicht kontrollieren Sie die D-Diagonale.

(NL) Installeer de volgende lagen en controleer diagonaal D.

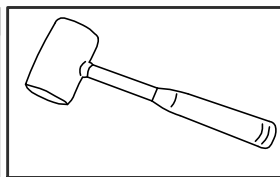
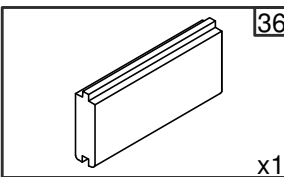
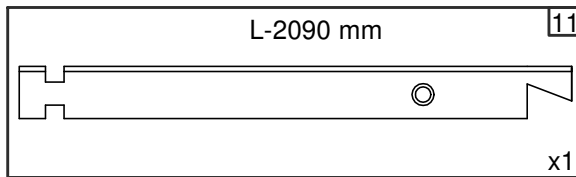
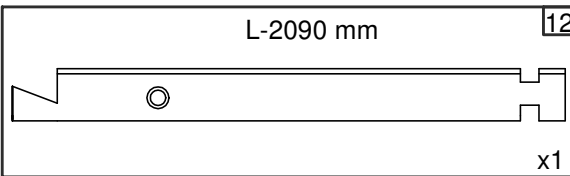
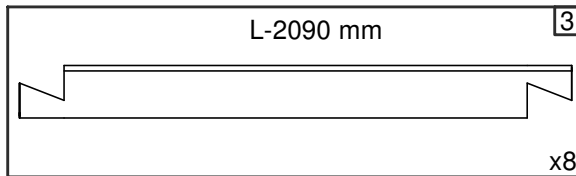
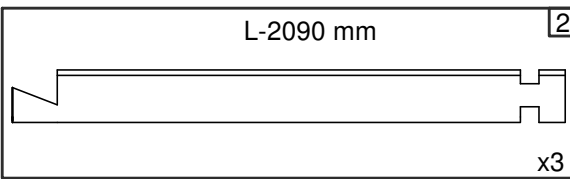
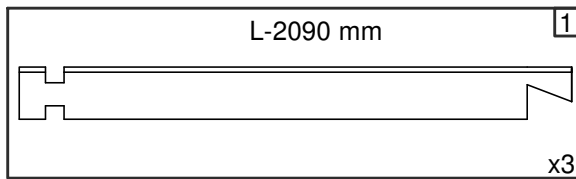

IV

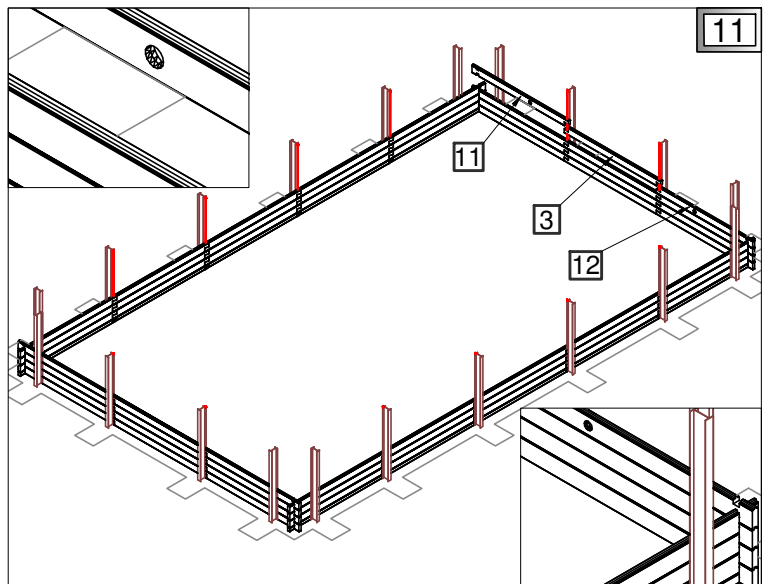
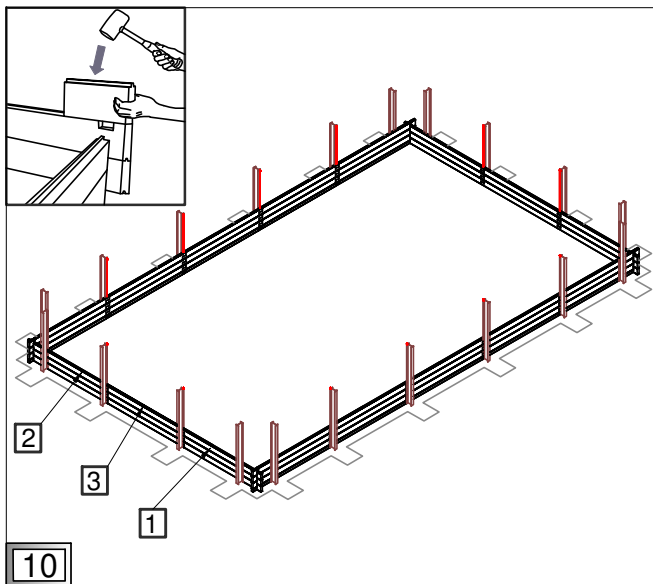
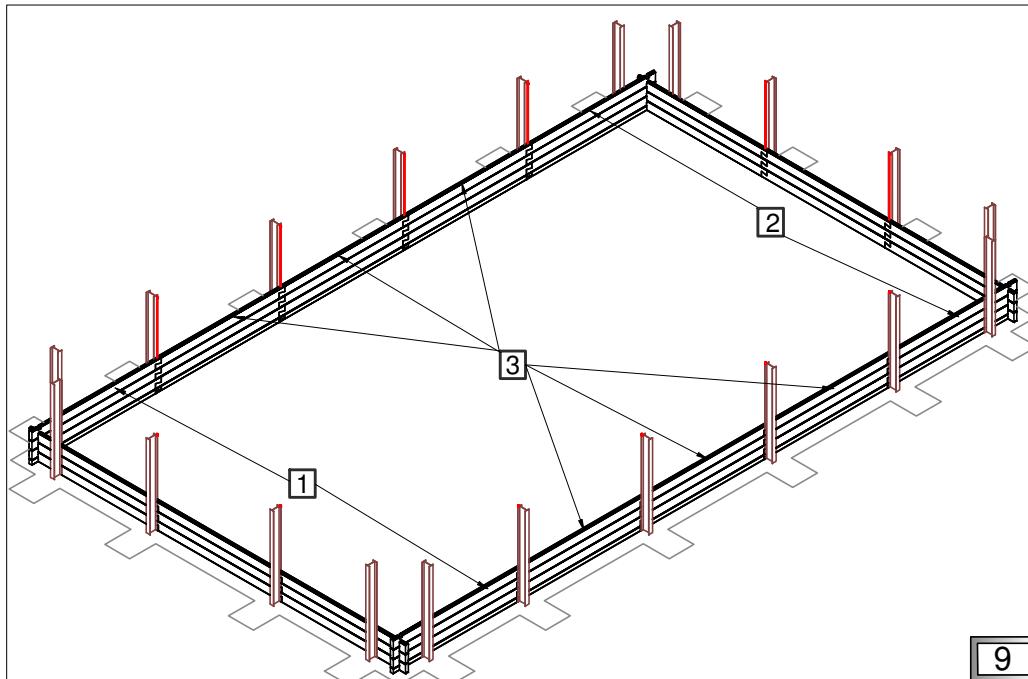

(PL) Struktura drewniana

(GB) Wooden structure

(DE) Holzstruktur

(FR) La structure bois

(IT) Struttura in legno

(NL) Houten structuur



(PL) Ułożenie kolejnych warstw. Sprawdzaj przekątną D po każdej ułożonej warstwie.

(FR) L'assemblage des couches suivantes. Vérifiez les diagonales "D" après la pose de chaque tour.

(GB) Putting next layers. Check D diagonals every layer.

(IT) La messa degli strati successivi. Trova la diagonale D dopo ogni strato.

(DE) Verlegen der nachfolgenden Schichten. Nach Verlegen von jeder Schicht kontrollieren Sie die D-Diagonale.

(NL) Installeer de volgende lagen en controleer diagonaal D.

V-VI

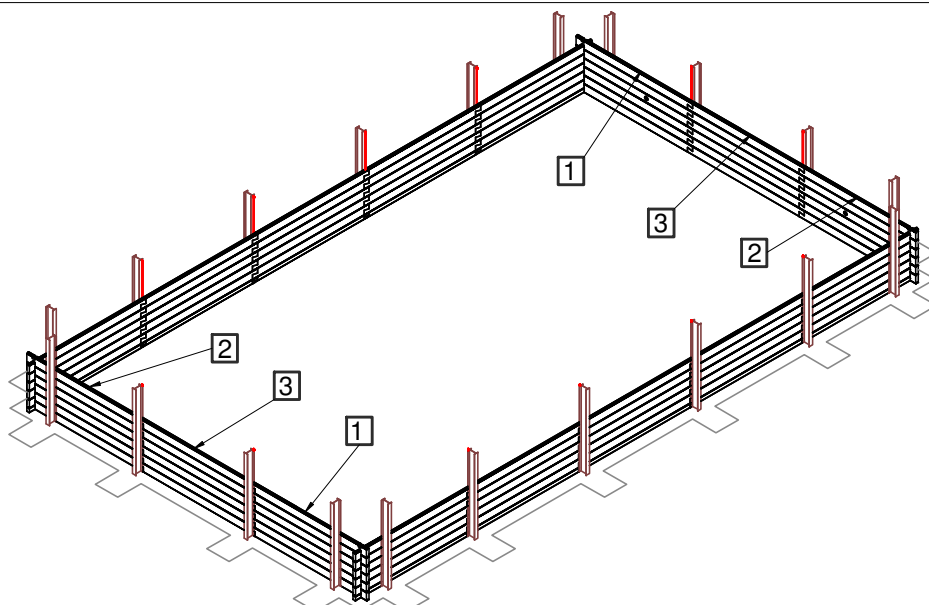
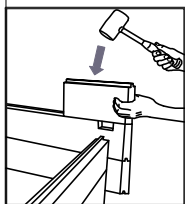
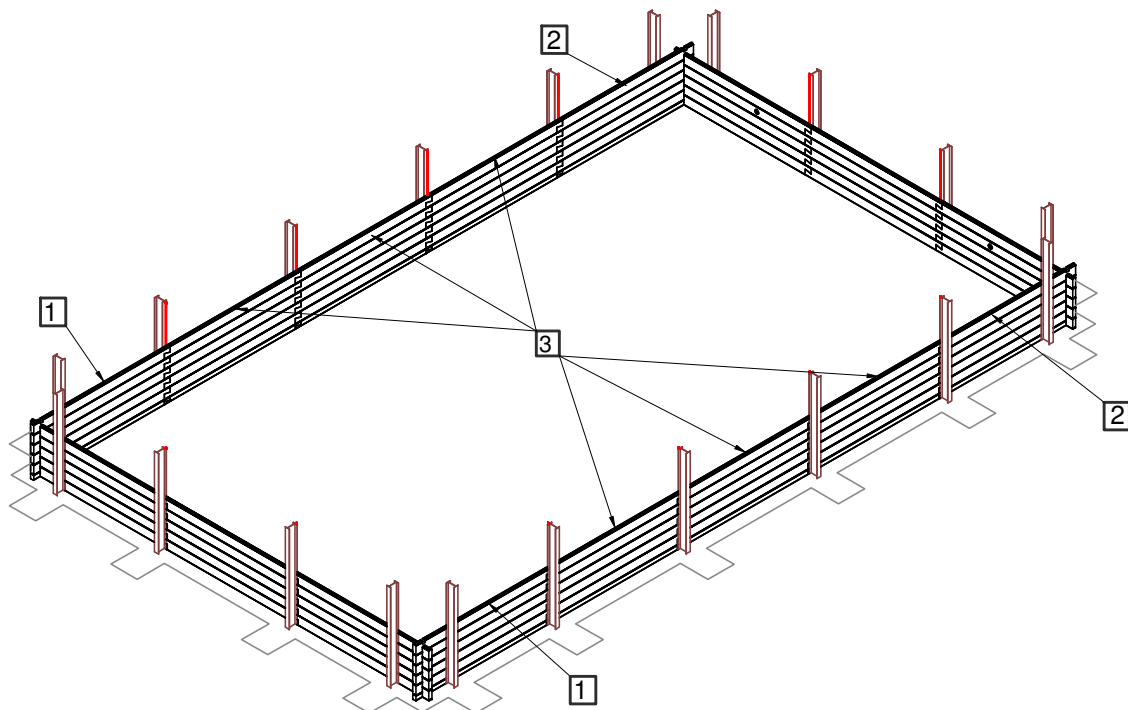
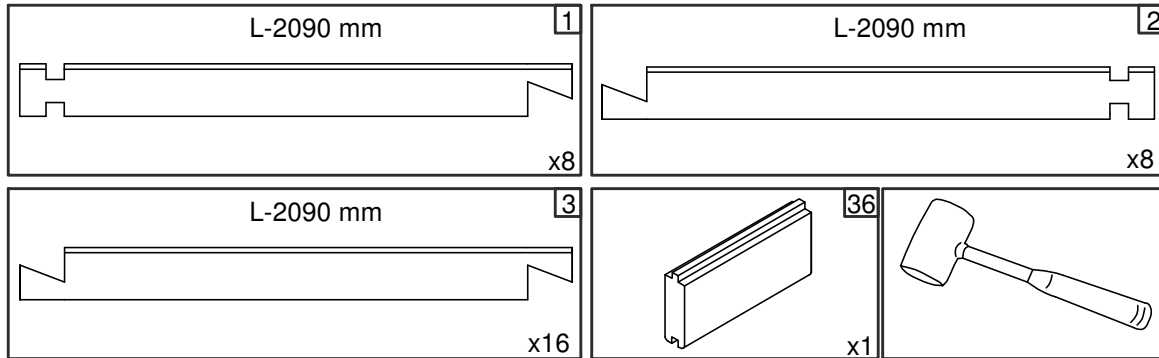

(PL) Struktura drewniana

(GB) Wooden structure

(DE) Holzstruktur

(FR) La structure bois

(IT) Struttura in legno

(NL) Houten structuur



(PL) Ułożenie kolejnych warstw. Sprawdzaj przekątną D po każdej ułożonej warstwie.

(FR) L'assemblage des couches suivantes. Vérifiez les diagonales "D" après la pose de chaque tour.

(GB) Putting next layers. Check D diagonals every layer.

(IT) La messa degli strati successivi. Trova la diagonale D dopo ogni strato.

(DE) Verlegen der nachfolgenden Schichten. Nach Verlegen von jeder Schicht kontrollieren Sie die D-Diagonale.

(NL) Installeer de volgende lagen en controleer diagonaal D.

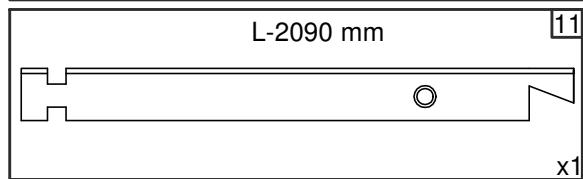
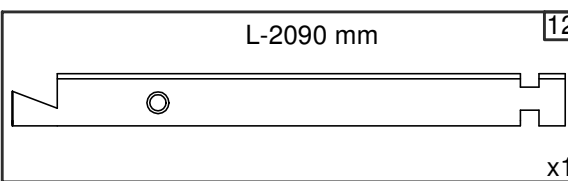
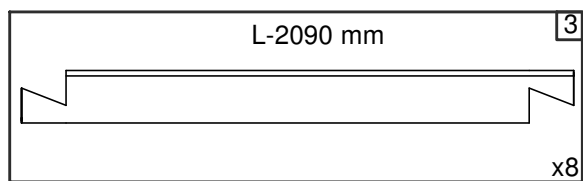
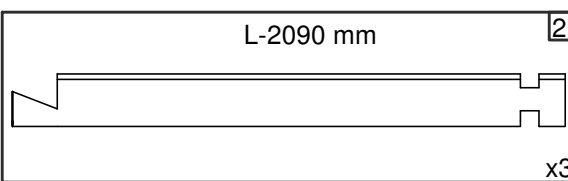
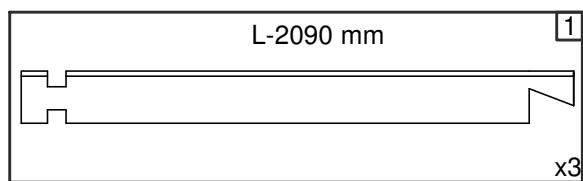

VII

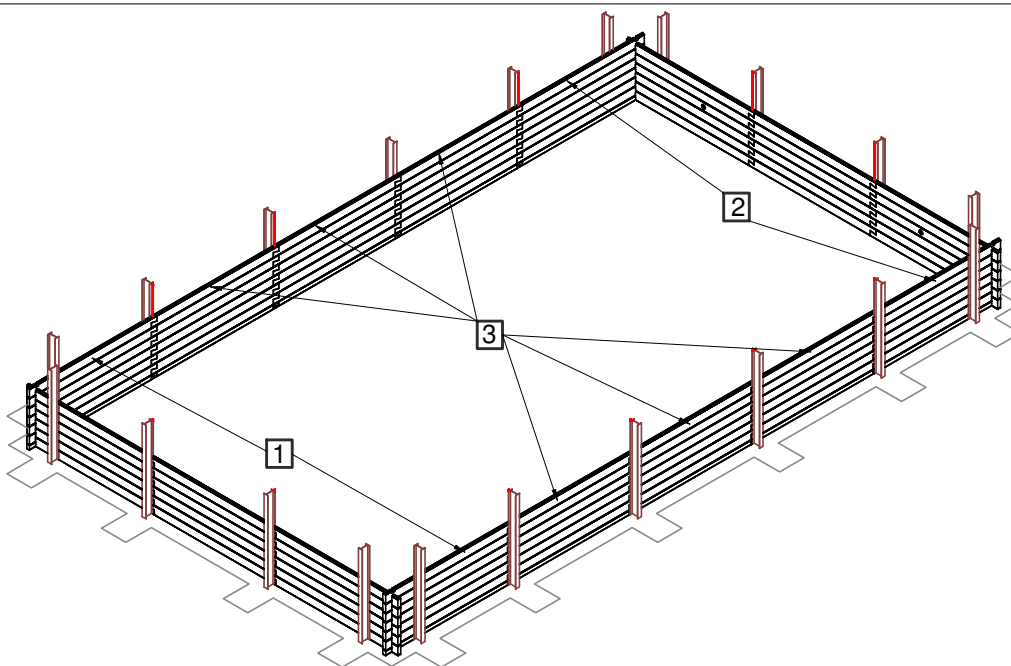

14

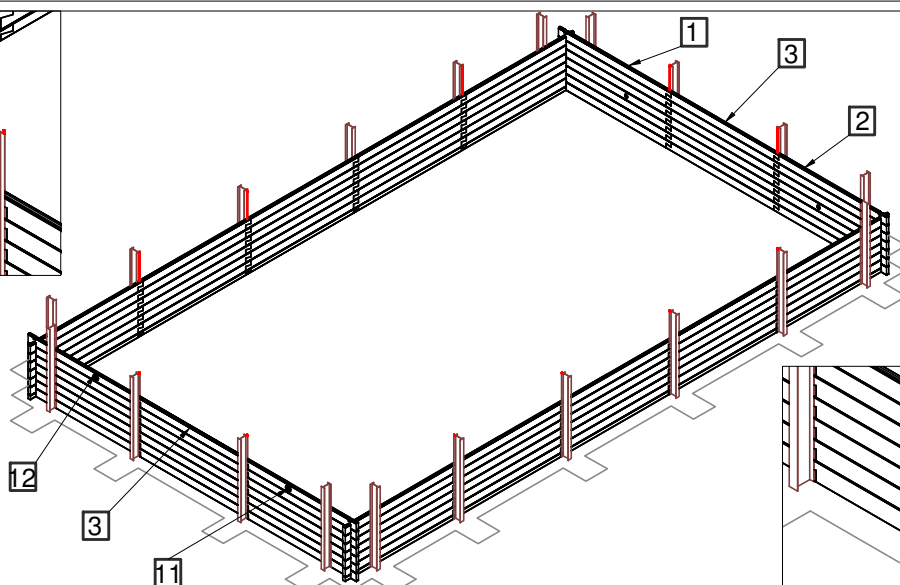
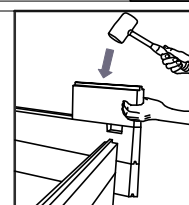
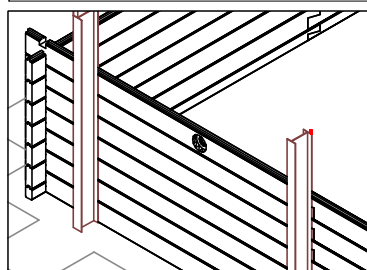

15

(PL) Struktura drewniana

(GB) Wooden structure

(DE) Holzstruktur

(FR) La structure bois

(IT) Struttura in legno

(NL) Houten structuur



(PL) Ułożenie kolejnych warstw. Sprawdzaj przekątną D po każdej ułożonej warstwie.

(FR) L'assemblage des couches suivantes. Vérifiez les diagonales "D" après la pose de chaque tour.

(GB) Putting next layers. Check D diagonals every layer.

(IT) La messa degli strati successivi. Trova la diagonale D dopo ogni strato.

(DE) Verlegen der nachfolgenden Schichten. Nach Verlegen von jeder Schicht kontrollieren Sie die D-Diagonale.

(NL) Installeer de volgende lagen en controleer diagonaal D.

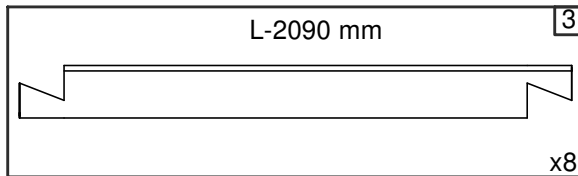
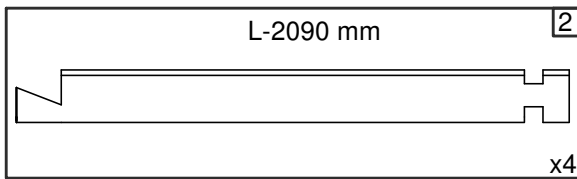
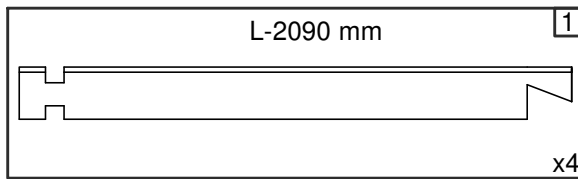

VIII

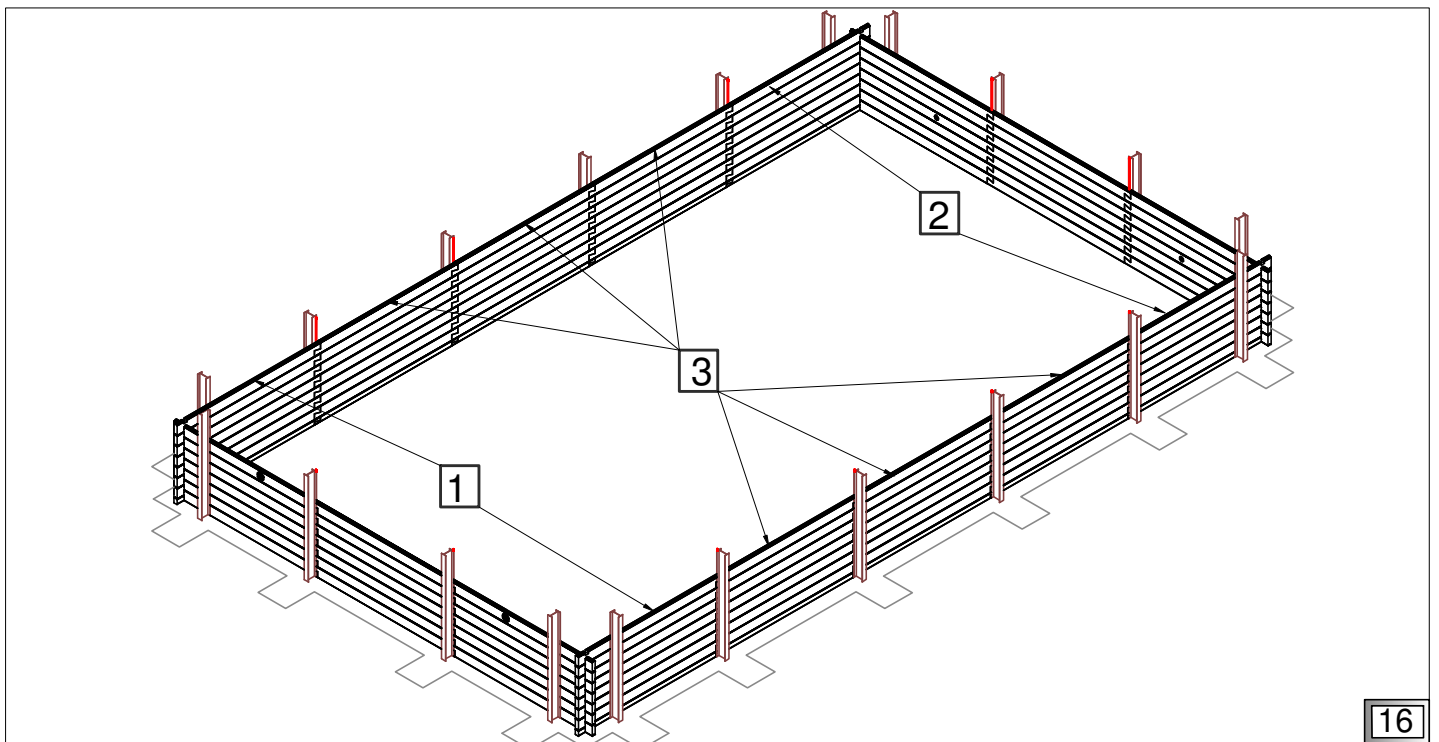

16

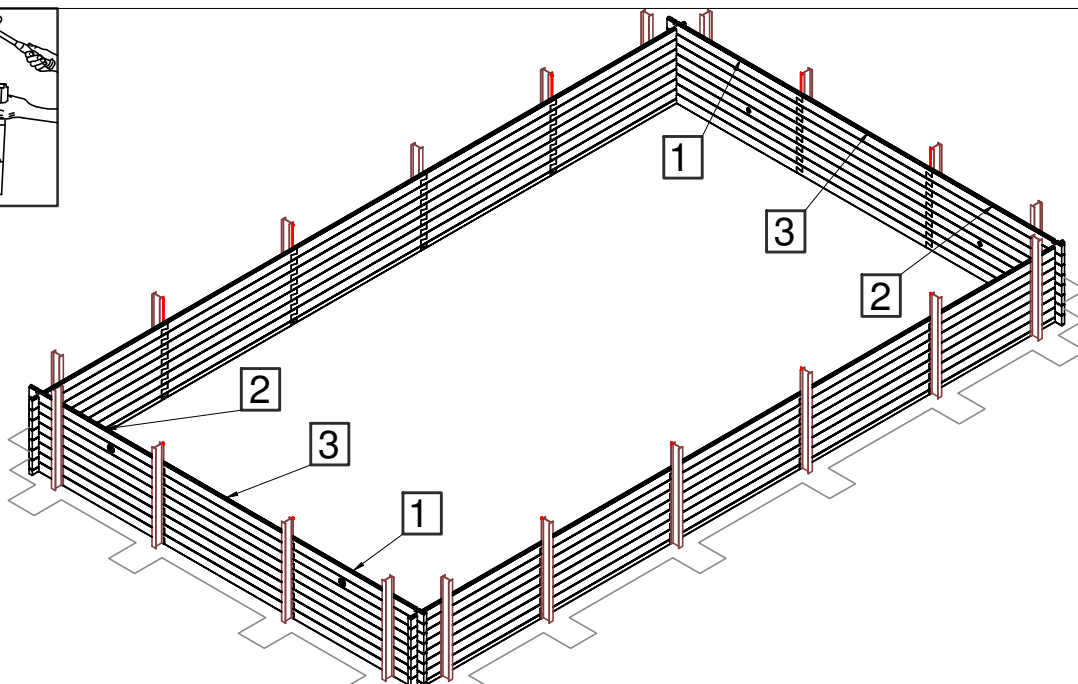
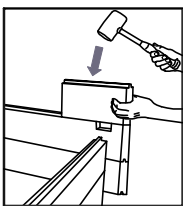

17

(PL) Struktura drewniana

(GB) Wooden structure

(DE) Holzstruktur

(FR) La structure bois

(IT) Struttura in legno

(NL) Houten structuur



(PL) Ułożenie kolejnych warstw. Sprawdzaj przekątną D po każdej ułożonej warstwie.

(FR) L'assemblage des couches suivantes. Vérifiez les diagonales "D" après la pose de chaque tour.

(GB) Putting next layers. Check D diagonals every layer.

(IT) La messa degli strati successivi. Trova la diagonale D dopo ogni strato.

(DE) Verlegen der nachfolgenden Schichten. Nach Verlegen von jeder Schicht kontrollieren Sie die D-Diagonale.

(NL) Installeer de volgende lagen en controleer diagonaal D.

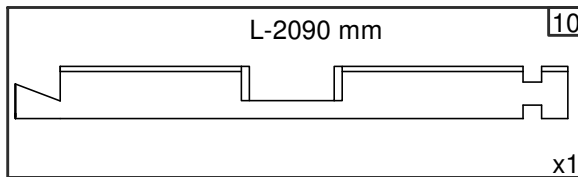
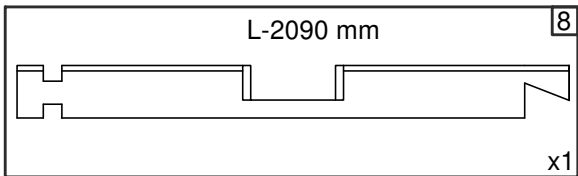
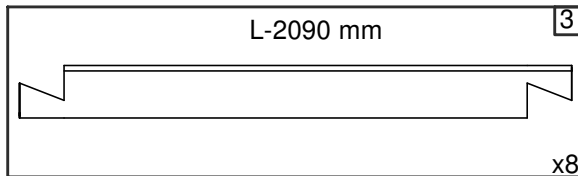
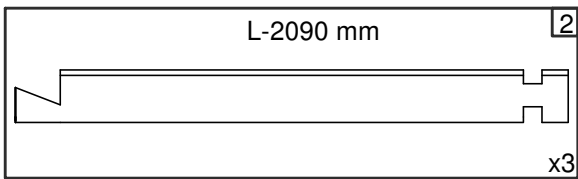
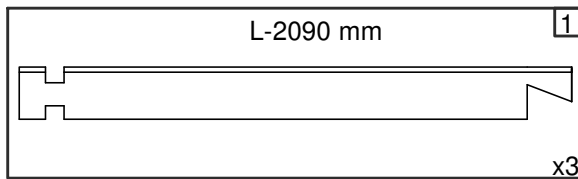

IX

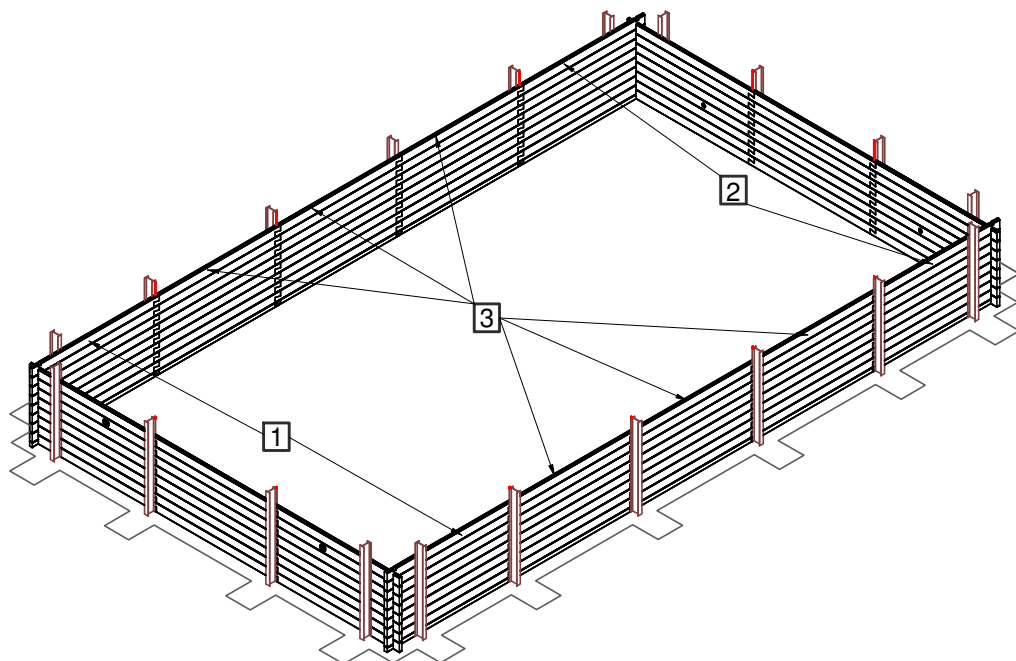

18

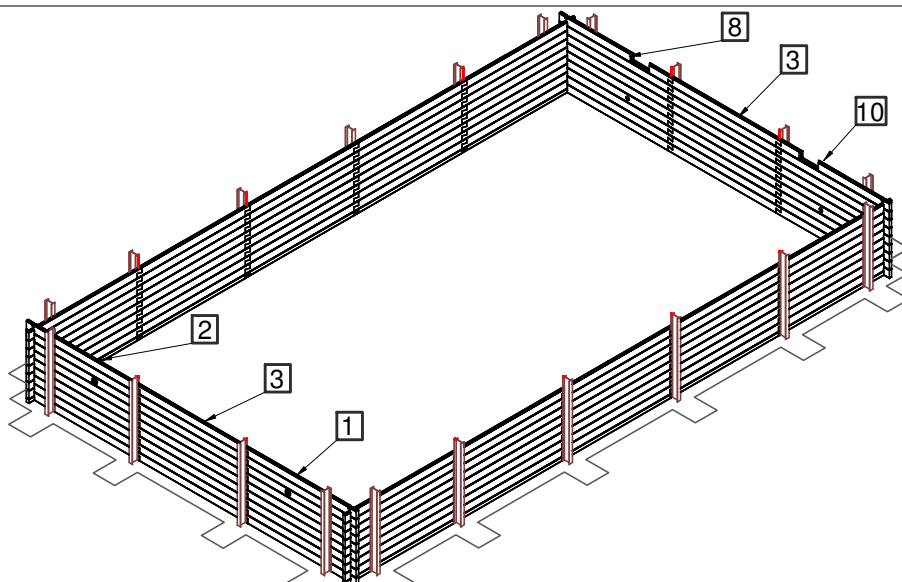
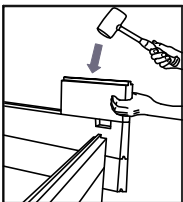

19

PL Struktura drewniana

GB Wooden structure

DE Holzstruktur

FR La structure bois

IT Struttura in legno

NL Houten structuur



PL Ułożenie kolejnych warstw. Sprawdzaj przekątne D po każdej ułożonej warstwie.

FR L'assemblage des couches suivantes. Vérifiez les diagonales "D" après la pose de chaque tour.

GB Putting next layers. Check D diagonals every layer.

IT La messa degli strati successivi. Trova la diagonale D dopo ogni strato.

DE Verlegen der nachfolgenden Schichten. Nach Verlegen von jeder Schicht kontrollieren Sie die D-Diagonale.

NL Installer de volgende lagen en controleer diagonaal D.

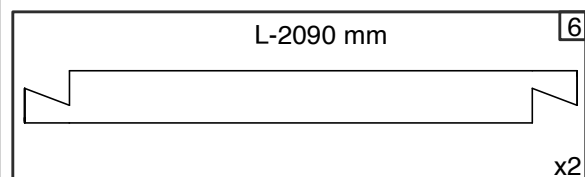
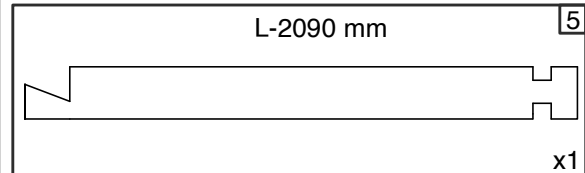
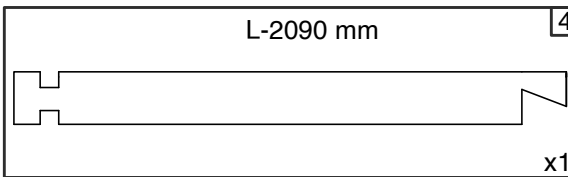
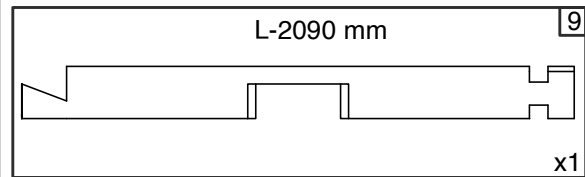
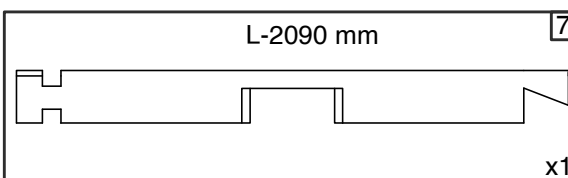
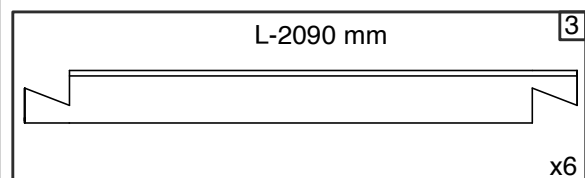
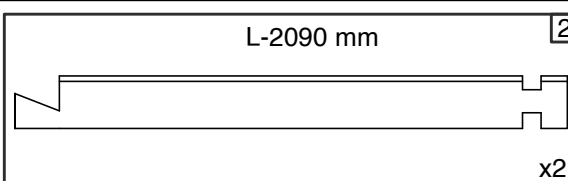
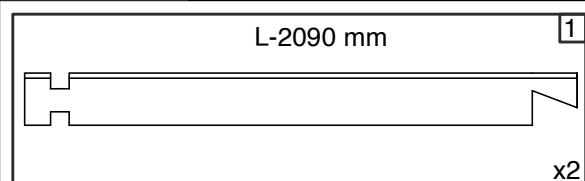

ATTENZIONE!
Posizionare lo SKIMMER prima di inserire la semitavola superiore. Vedi le istruzioni di montaggio degli accessori per tutti i dettagli.

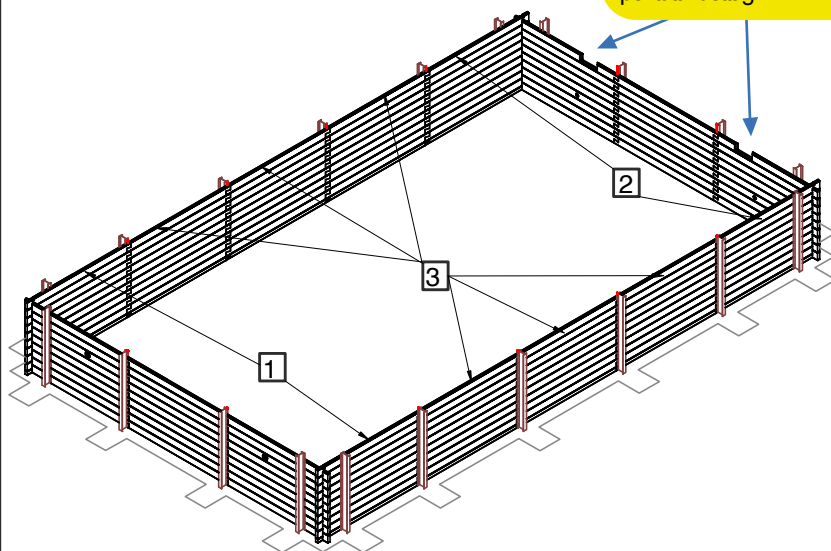

20

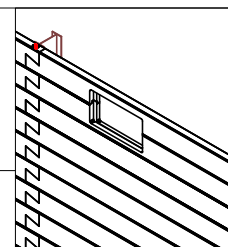
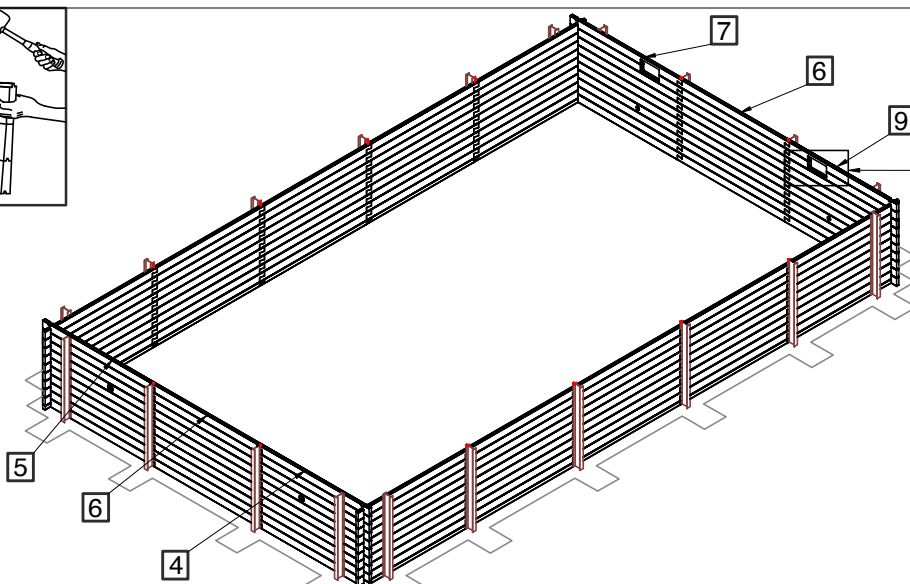
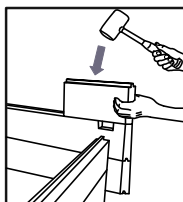

21

(PL) Struktura drewniana

(GB) Wooden structure

(DE) Holzstruktur

(FR) La structure bois

(IT) Struttura in legno

(NL) Houten structuur



(PL) Ułożenie kolejnych warstw. Sprawdzaj przekątną D po każdej ułożonej warstwie.

(FR) L'assemblage des couches suivantes. Vérifiez les diagonales "D" après la pose de chaque tour.

(GB) Putting next layers. Check D diagonals every layer.

(IT) La messa degli strati successivi. Trova la diagonale D dopo ogni strato.

(DE) Verlegen der nachfolgenden Schichten. Nach Verlegen von jeder Schicht kontrollieren Sie die D-Diagonale.

(NL) Installeer de volgende lagen en controleer diagonaal D.

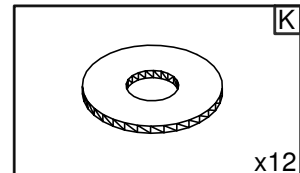
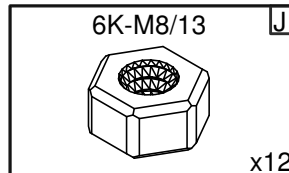
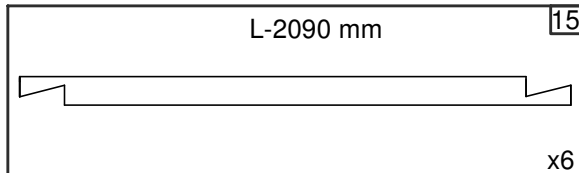
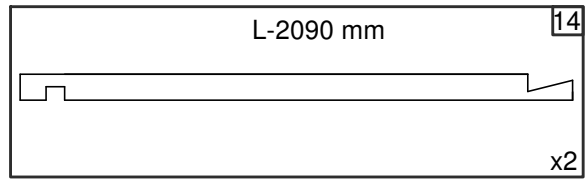
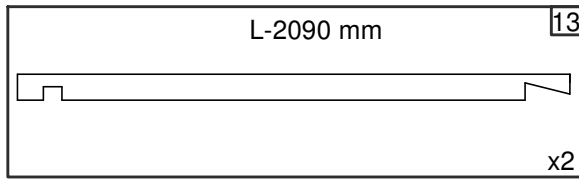

XI

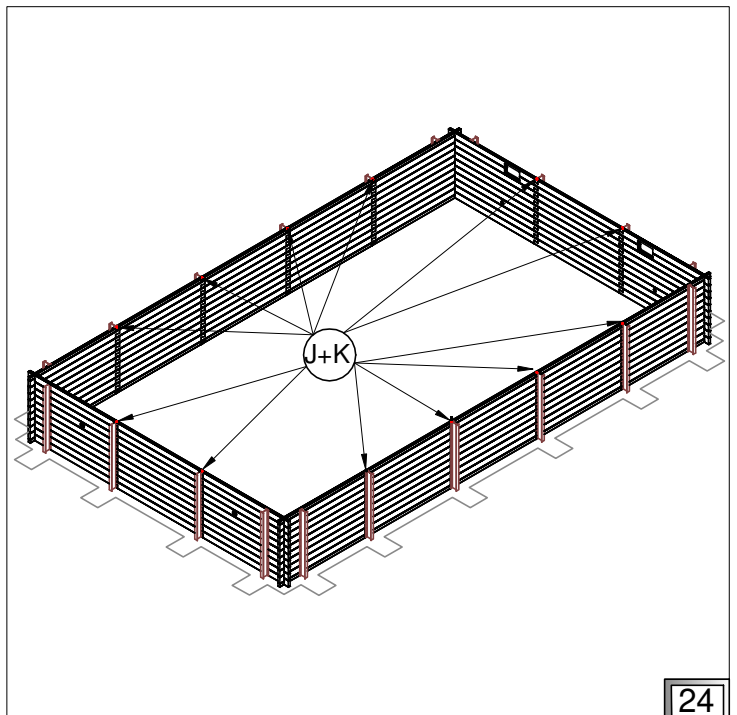
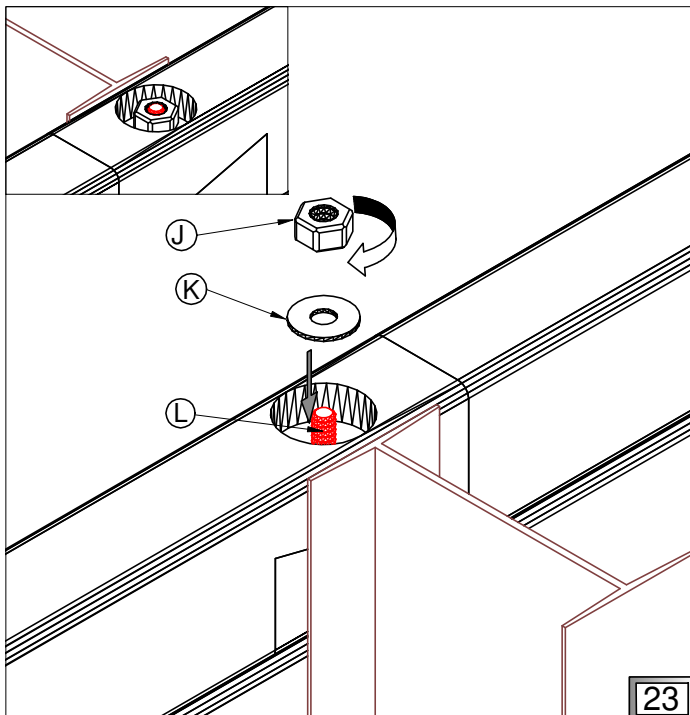
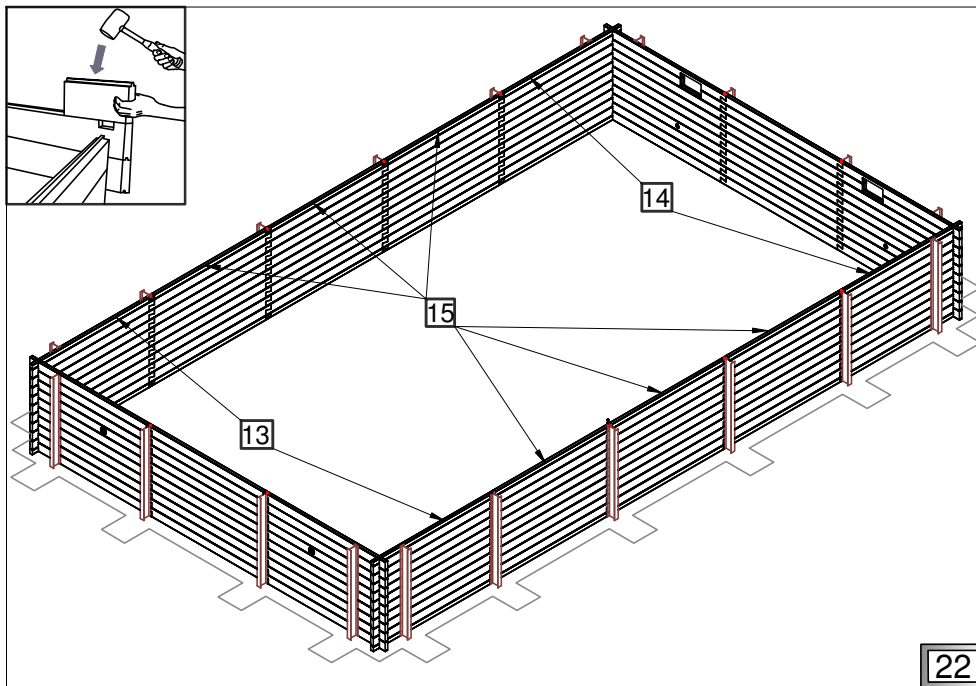

(PL) Struktura drewniana

(GB) Wooden structure

(DE) Holzstruktur

(FR) La structure bois

(IT) Struttura in legno

(NL) Houten structuur



(PL) Ułożenie kolejnych warstw.

(FR) L'assemblage des couches suivantes.

(GB) Putting next layers.

(IT) La messa degli strati successivi.

(DE) Verlegen der nachfolgenden Schichten.

(NL) Installeer de volgende lagen.

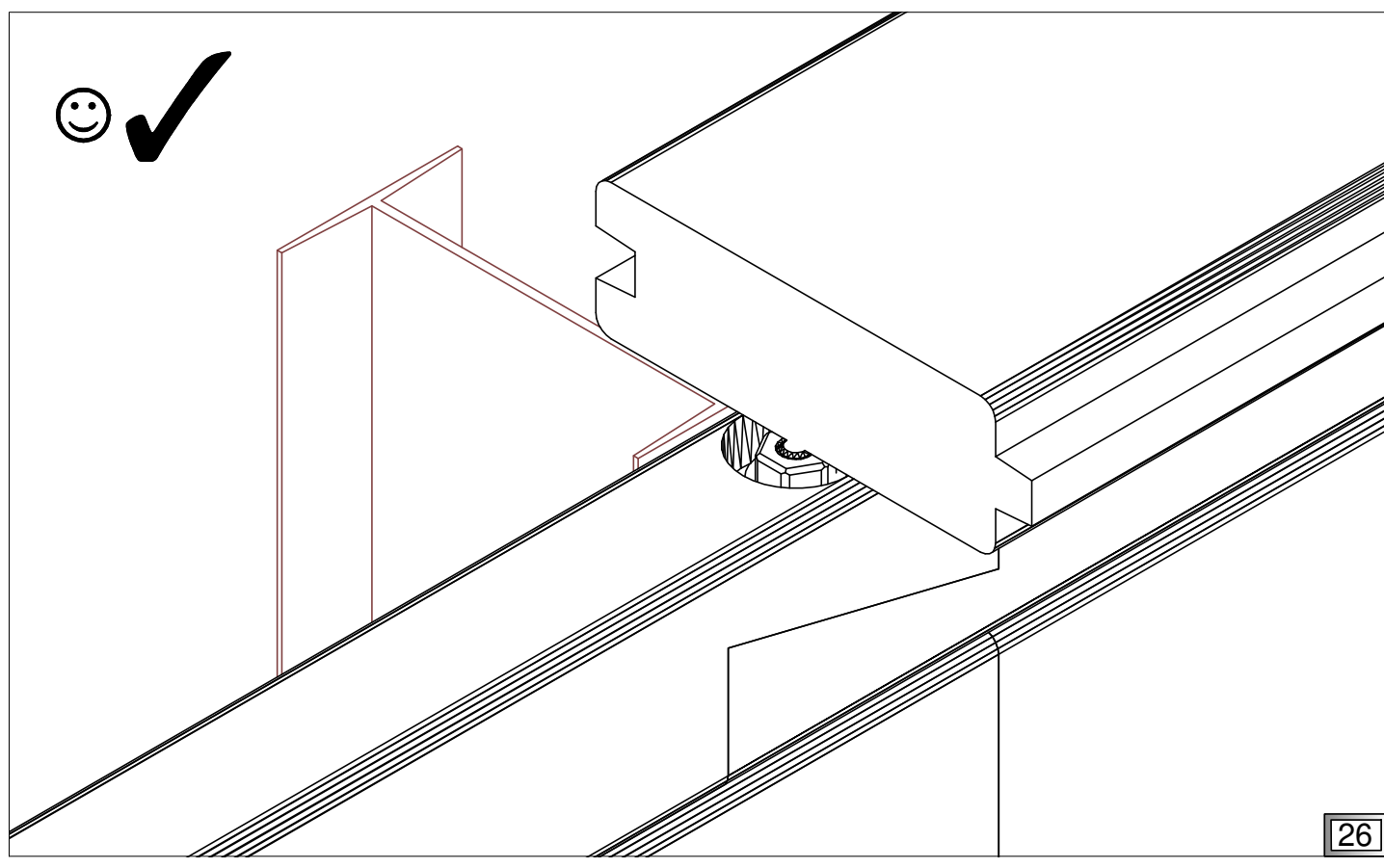
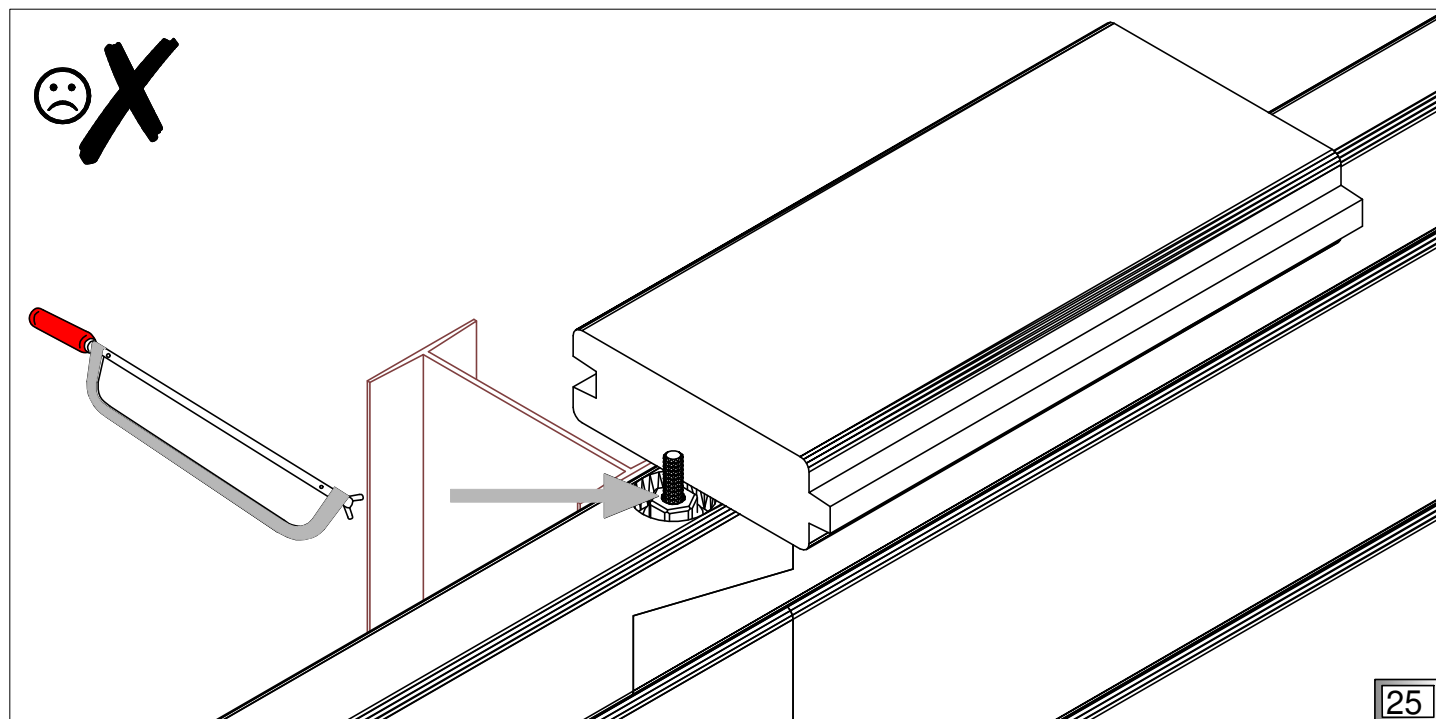
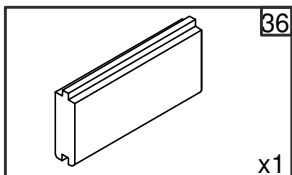
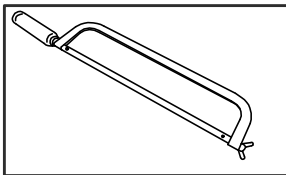

(PL) Struktura drewniana

(GB) Wooden structure

(DE) Holzstruktur

(FR) La structure bois

(IT) Struttura in legno

(NL) Houten structuur



- (PL)** Montaż wspornika schodów (28).
- (FR)** Le montage du renfort d'escalier (28).
- (GB)** Installation of stairs support (28).
- (IT)** Montaggio delle scale a sbalzo (28).
- (DE)** Montage von Treppenstützen (28).
- (NL)** Installatie van de steun voor de trap (28).

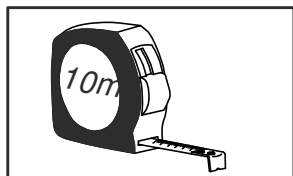
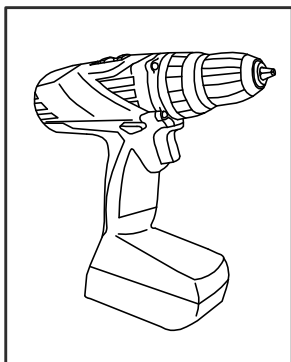

[mm]

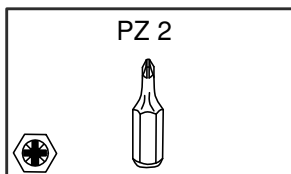
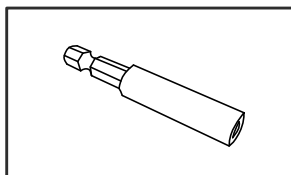
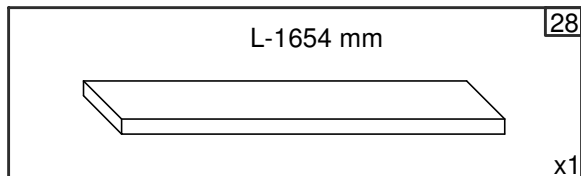

PZ 2

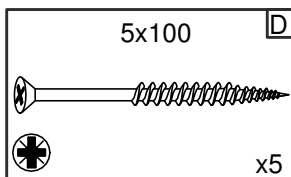

5x100

x5

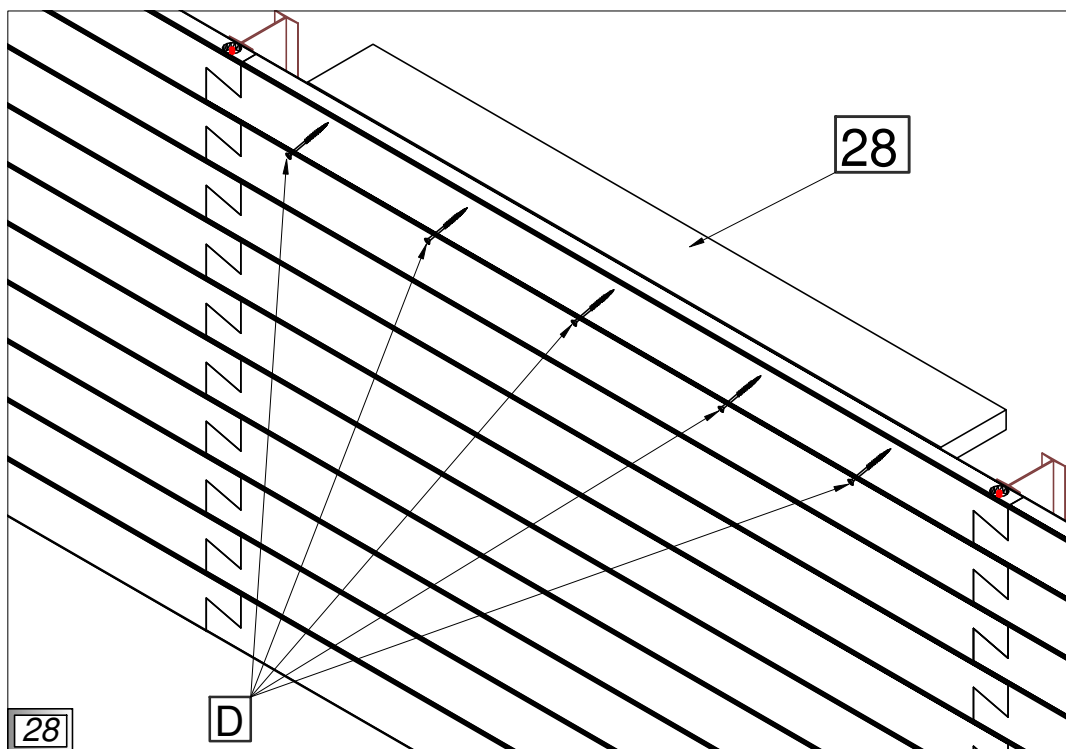
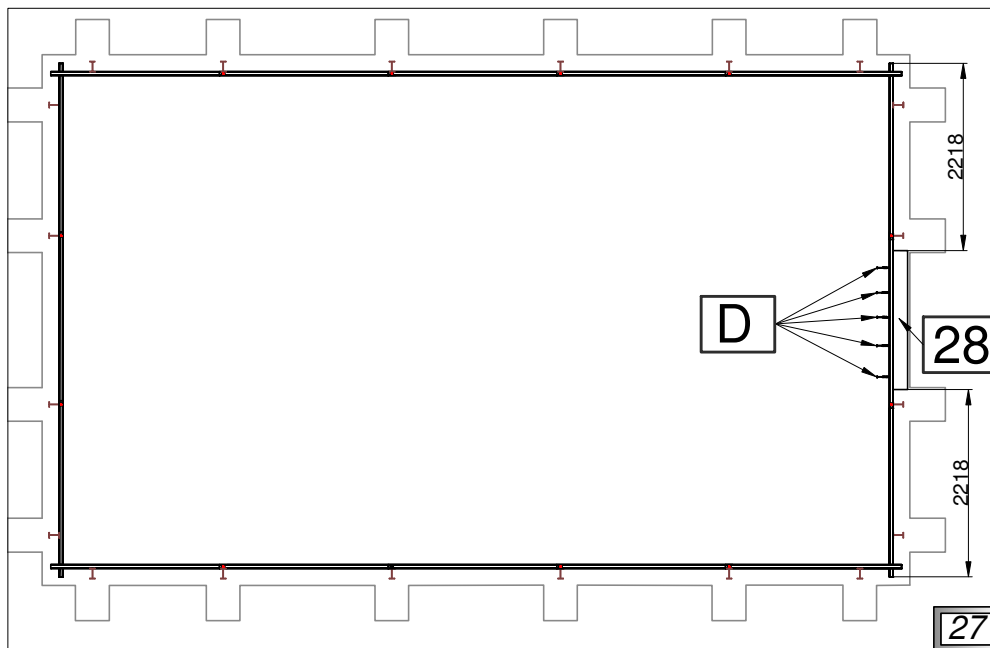

(PL) Struktura drewniana

(GB) Wooden structure

(DE) Holzstruktur

(FR) La structure bois

(IT) Struttura in legno

(NL) Houten structuur



(PL) Rozłożenie wsporników pionowych (30;29) oraz konsol (34) według schematu.

(FR) La disposition des renforts verticaux (30;29) et des supports des margelles (34) d'après le schéma.

(GB) Arrangement of vertical supports (30;29) and consoles (34) according to the drawing.

(IT) La distribuzione degli sbalzi verticali (30;29) e delle console (34), secondo lo schema.

(DE) Verteilung der vertikalen Stützen (30;29) und Konsolen (34) nach Schema.

(NL) Montage van de verticale steunen (30;29) en de consoles (34) volgens tekening.

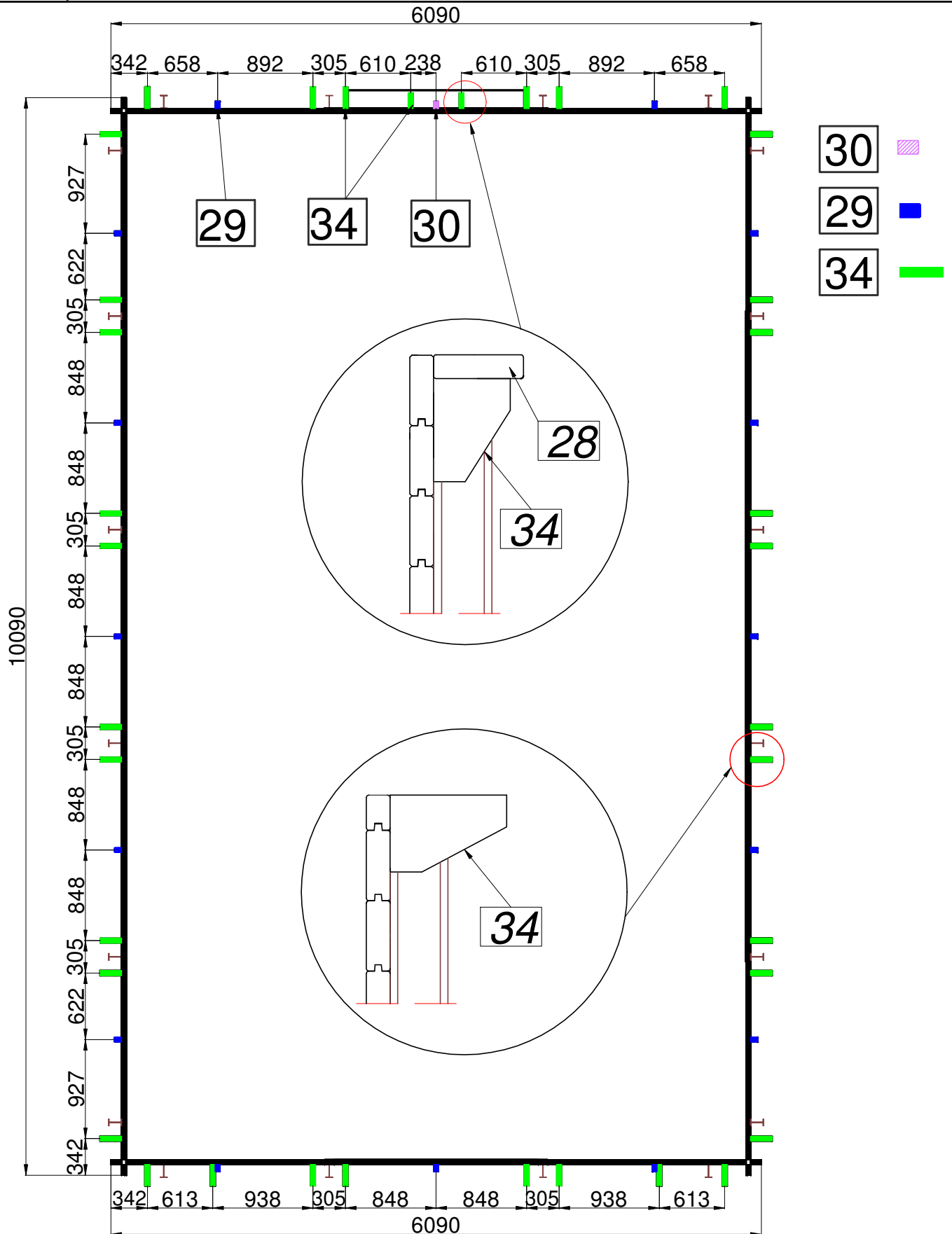

(PL) Struktura drewniana

(GB) Wooden structure

(DE) Holzstruktur

(FR) La structure bois

(IT) Struttura in legno

(NL) Houten structuur



(PL) Montaż konsol (34). Konsole montowane pod wspornikiem schodów (28).

(FR) Le montage des supports des margelles (34). Montez les supports des margelles sous un renfort d'escalier (28).

(GB) Installation of consoles (34). Consoles under ladder support (28).

(IT) Il montaggio di consolle (34). Consolle sono montate sotto lo sbalzo della scala (28).

(DE) Konsolenmontage (34). Die Konsolen werden unter den Treppenstützen (28).

(NL) Installatie van de consoles (34). Consoles onder de ladder steun (28).

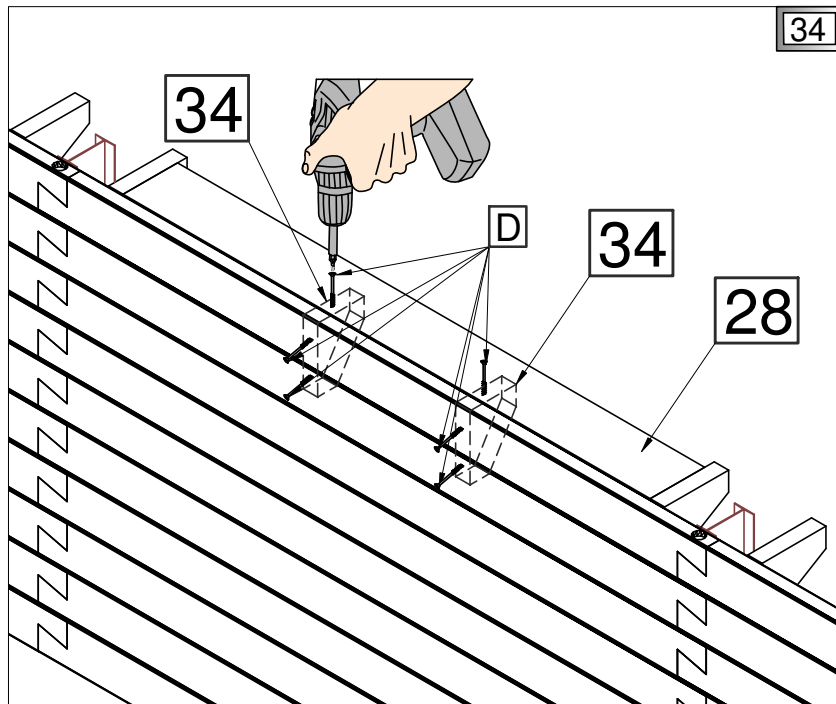
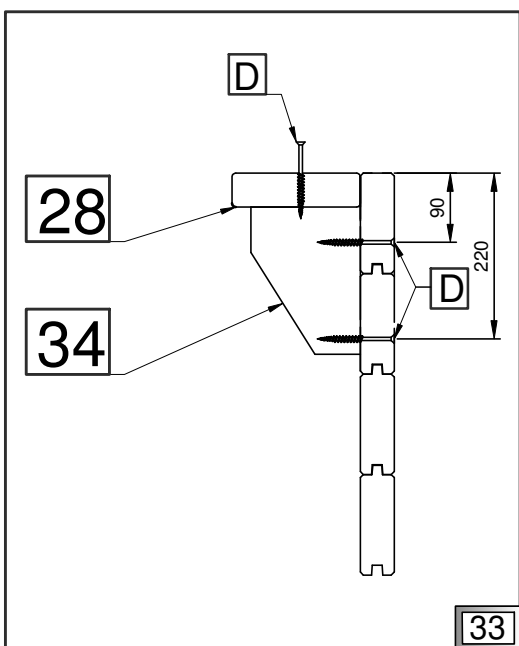
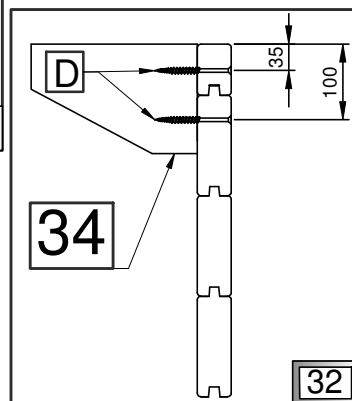
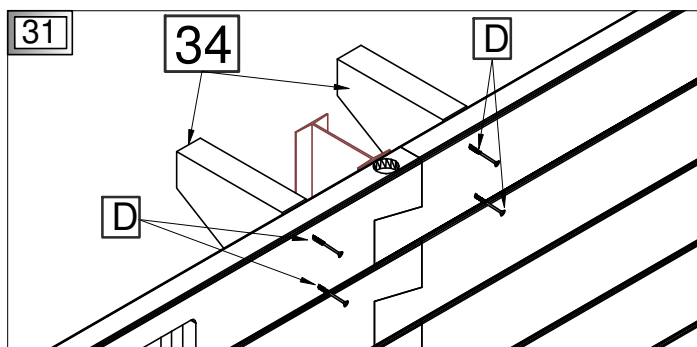
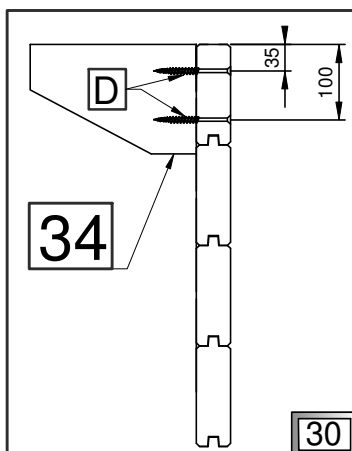
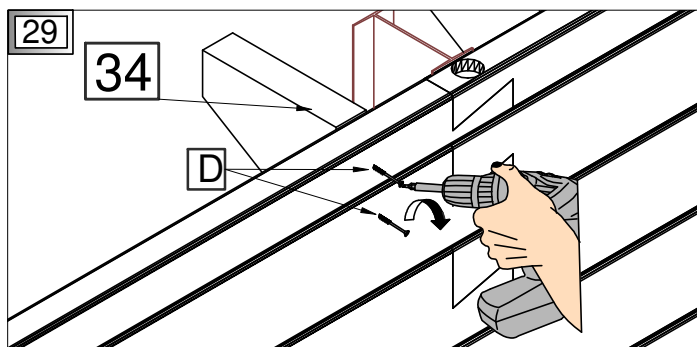
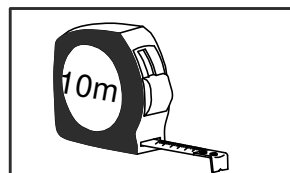
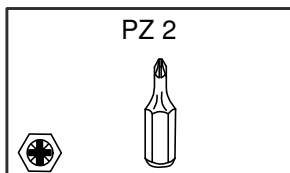
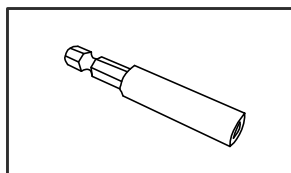
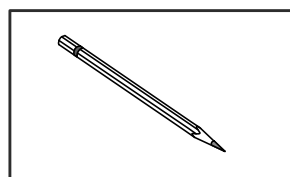
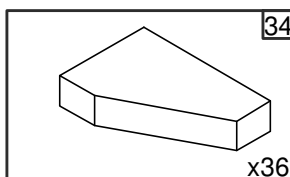
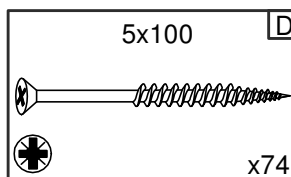
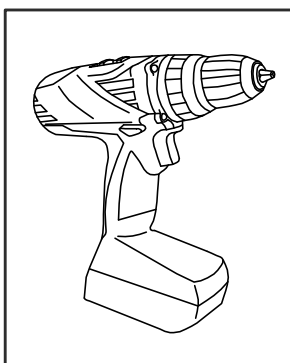

(PL) Struktura drewniana

(GB) Wooden structure

(DE) Holzstruktur

(FR) La structure bois

(IT) Struttura in legno

(NL) Houten structuur



(PL) Montaż wsporników pionowych (29). Wkręty rozmieszczają według rysunku 36;37.

(FR) Le montage des renforts verticaux (29). La disposition des vis d'après le dessin 36;37.

(GB) Installation of vertical supports (29). Arrange screws according to the drawing 36;37.

(IT) Montaggio degli sbalzi verticali (29). Mettere viti secondo il disegno 36;37.

(DE) Montage von vertikalen Stützen (29). Schrauben sind nach Abb 36;37 angebracht.

(NL) Installatie van de verticale steunen (29), bepaal de schroeven volgens tekening 36;37.

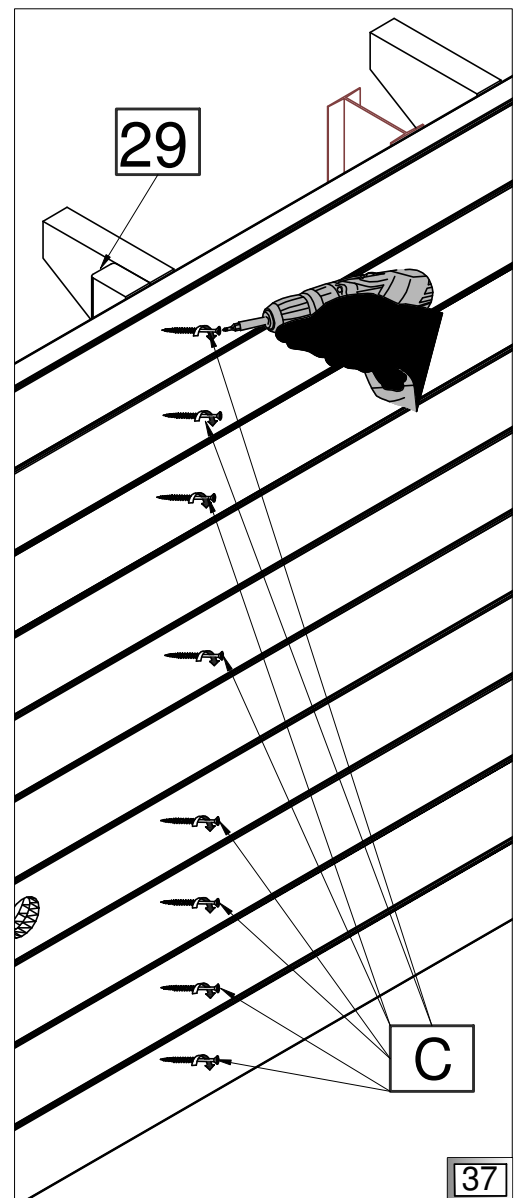
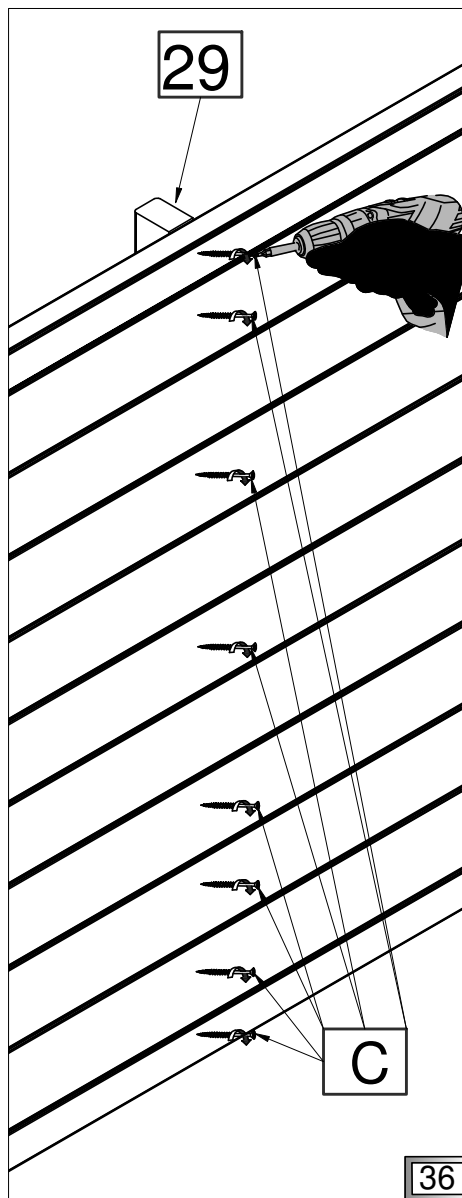
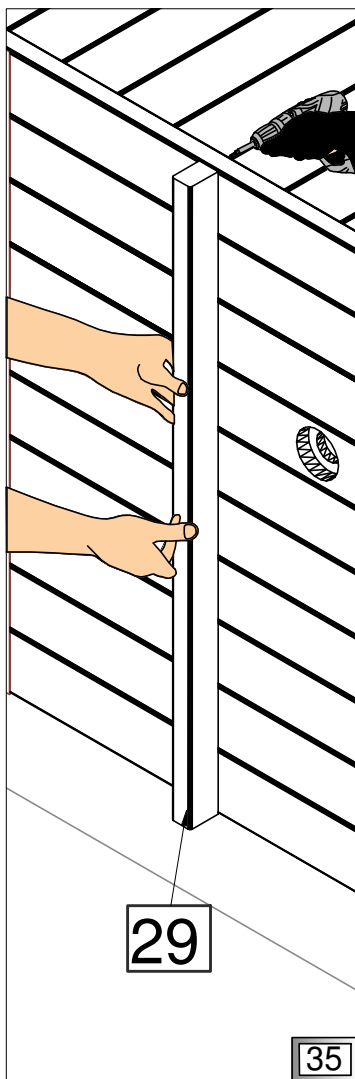
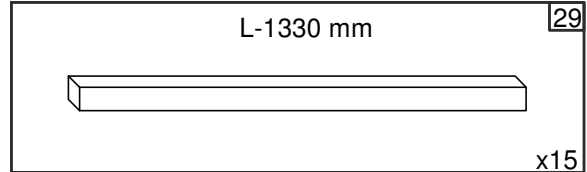
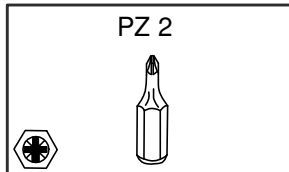
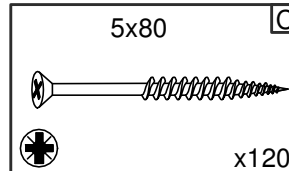
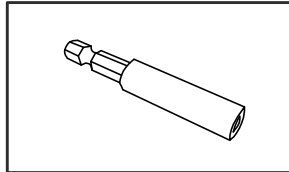
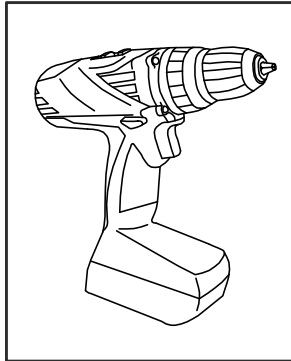

(PL) Struktura drewniana

(GB) Wooden structure

(DE) Holzstruktur

(FR) La structure bois

(IT) Struttura in legno

(NL) Houten structuur



(PL) Montaż wsporników pionowych (30) pod wspornikiem schodów (28).

(FR) Le montage des renforts verticaux (30) sous un renfort d'escalier (28).

(GB) Installation of vertical supports (30) under the ladder support (28).

(IT) Installazione degli sbalzi verticali (30) sotto lo sbalzo delle scale (28).

(DE) Montage von vertikalen Stützen (30) unter den Treppenstützen (28).

(NL) Installatie van de verticale steunen (30) onder de ladder steun (28).

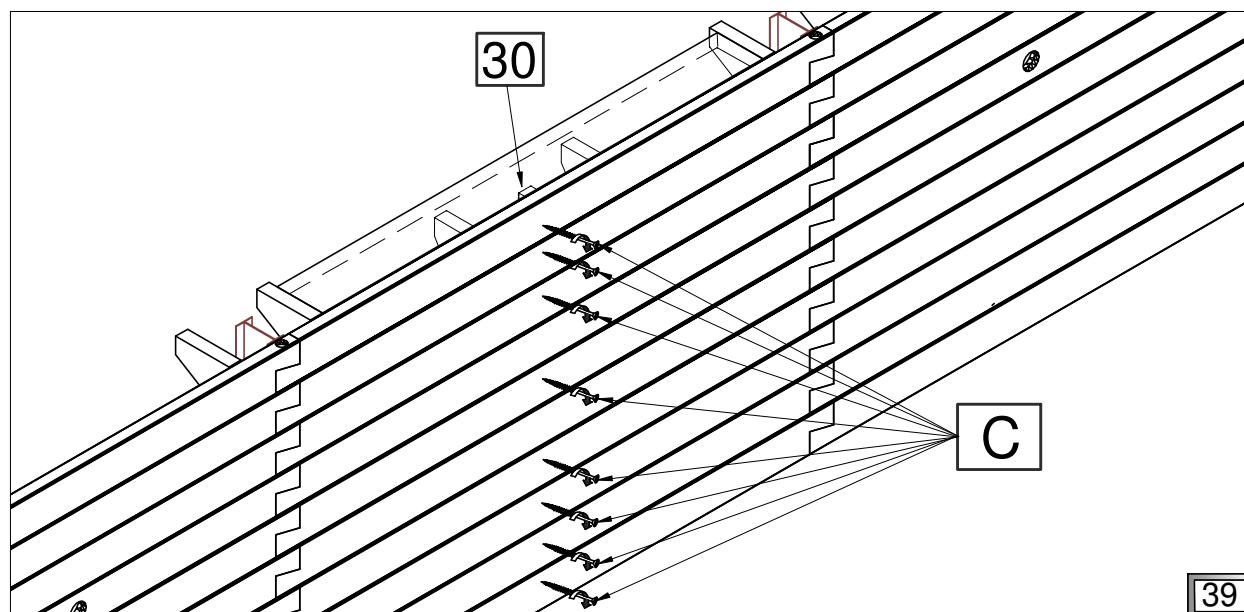
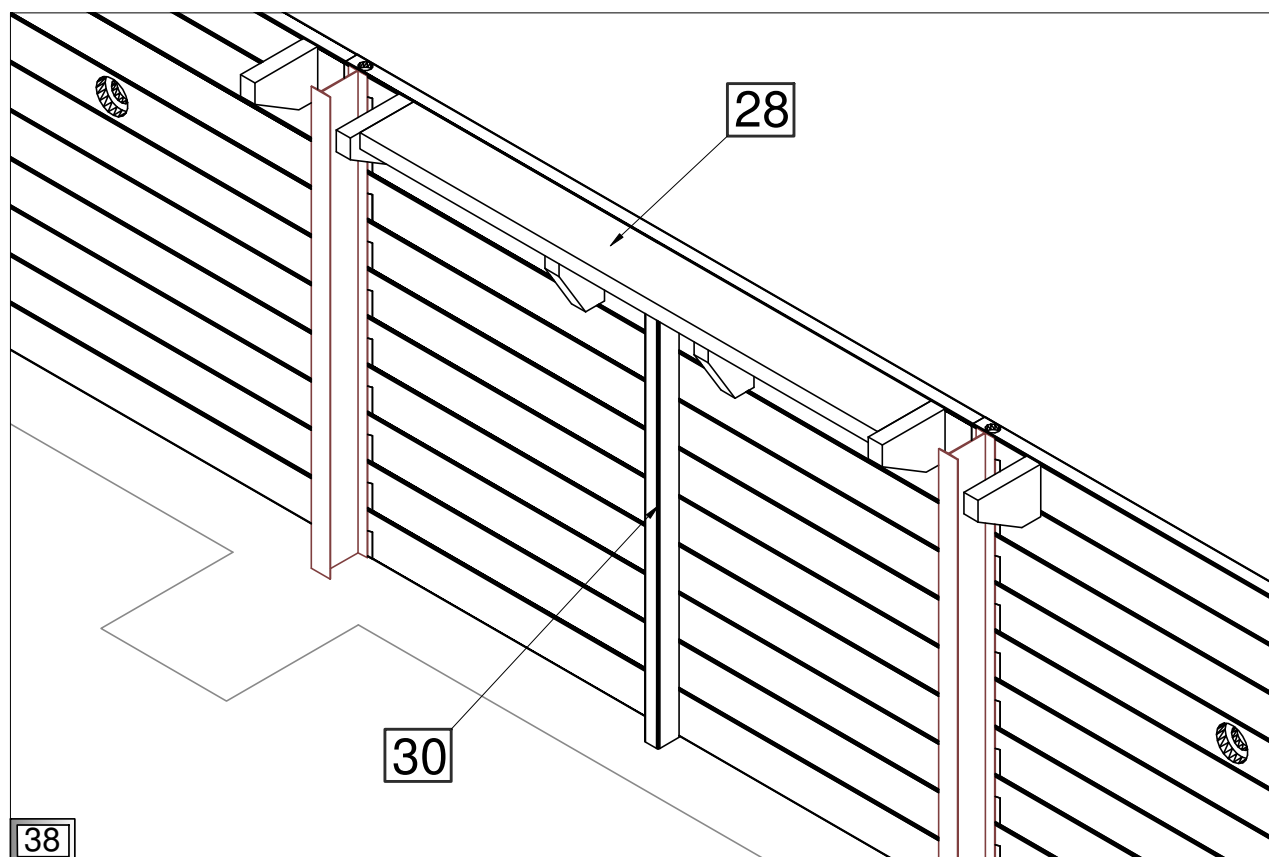
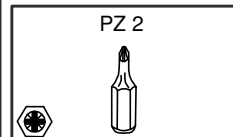
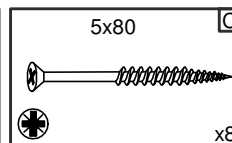
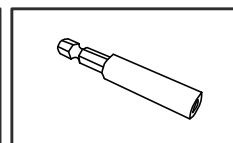
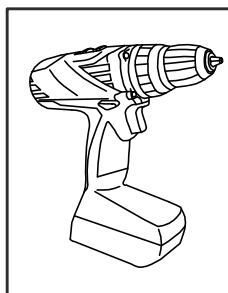
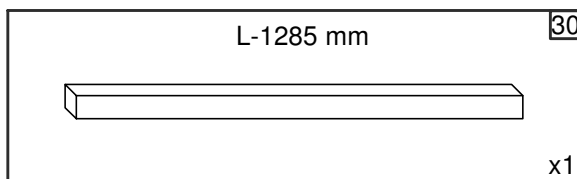

PL Struktura drewniana

GB Wooden structure

DE Holzstruktur

FR La structure bois

IT Struttura in legno

NL Houten structuur



PL Maskowanie słupków metalowych 2T (T1) maskownicami (32;31).

FR La fixation des caches (32;31) pour les poteaux métalliques 2T (T1).

GB Covering steel bars 2T (T1) with masking elements (32;31).

IT Mascherare i pilastri di metallo 2T (T1) con i mascherini (32;31).

DE Verdeckung von 2T-Metallsäulen (T1) mit Abdeckungen (32;31).

NL Afdekken van de stalen balken 2T (T1) met afwerklatten (32;31).

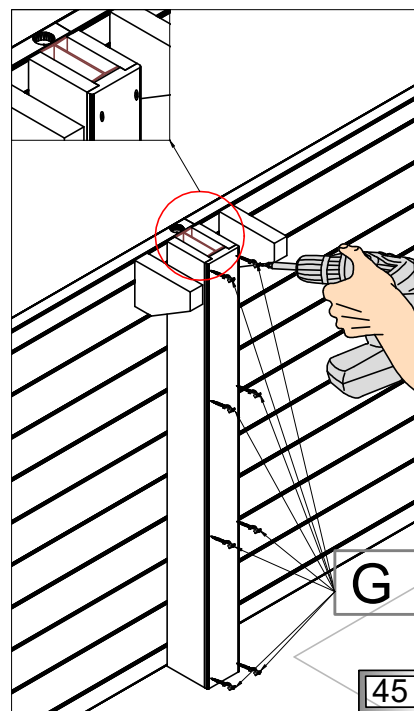
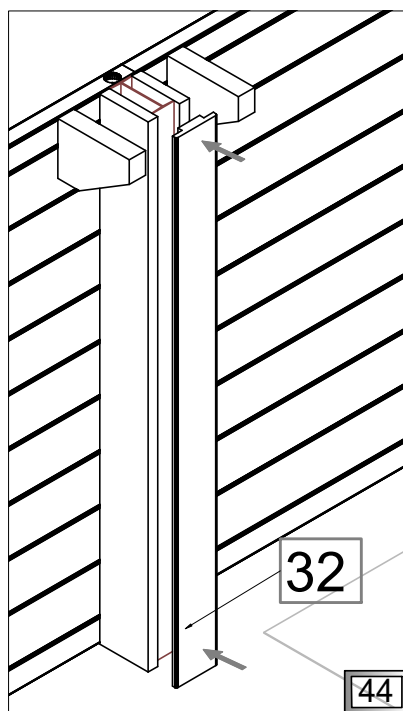
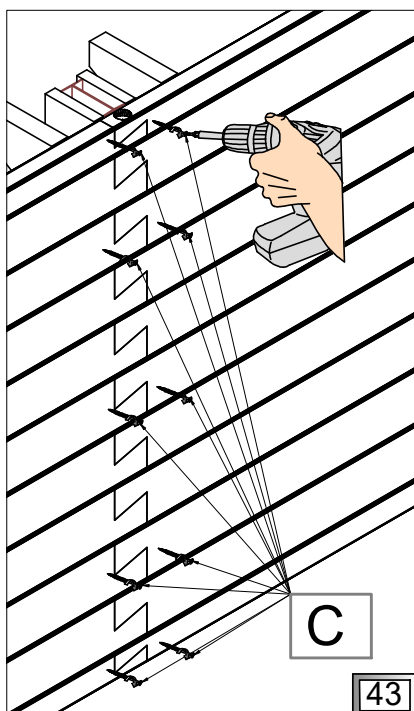
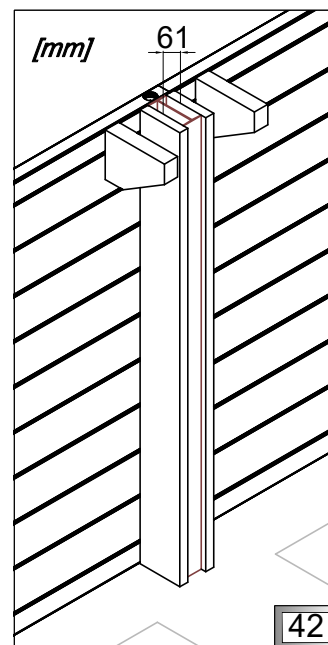
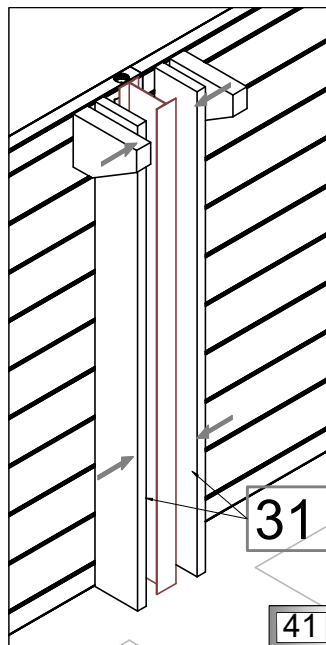
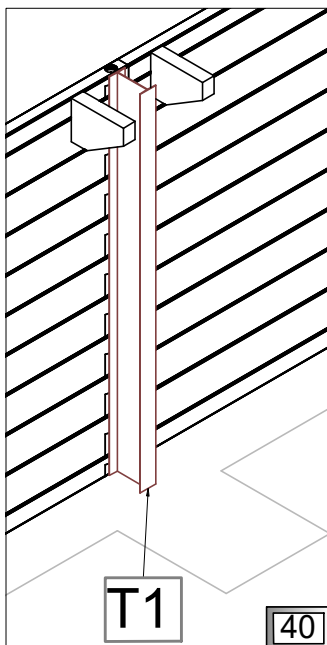
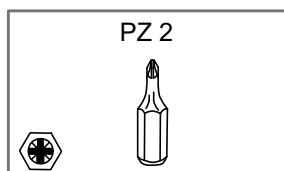
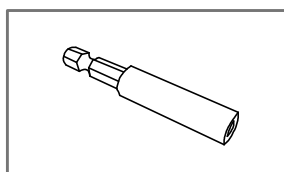
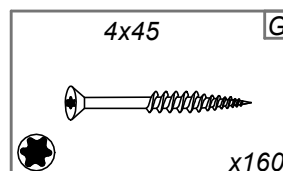
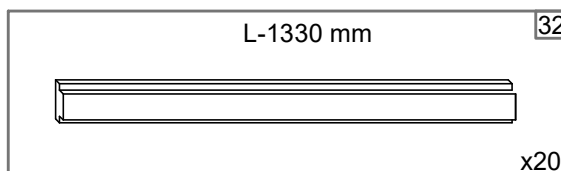
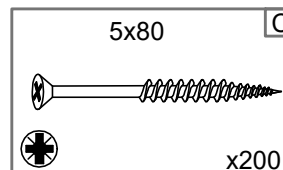
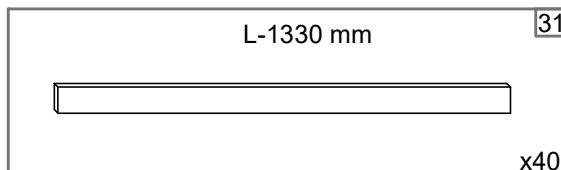
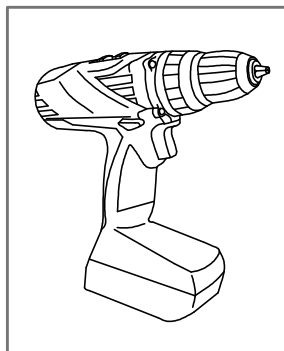

PL Struktura drewniana

GB Wooden structure

DE Holzstruktur

FR La structure bois

IT Struttura in legno

NL Houten structuur



PL Montaż maskownicy (33).

FR Le montage des caches (33).

GB Installation of the masking element (33).

IT Montaggio del mascherino (33).

DE Montage der Abdeckung (33).

NL Installatie van de afwerklát (33) voor de kopse kanten van de wanddelen.

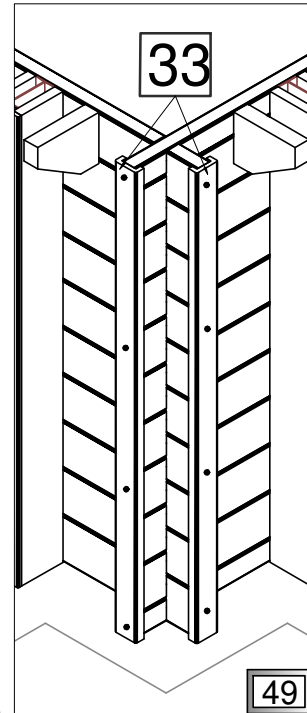
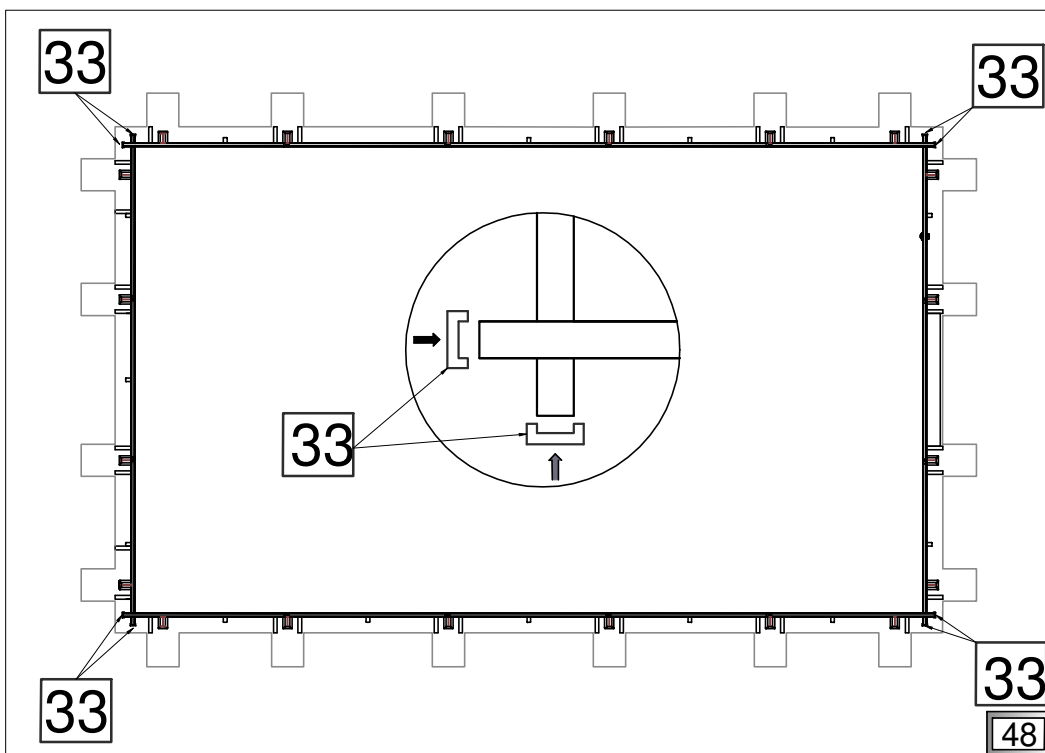
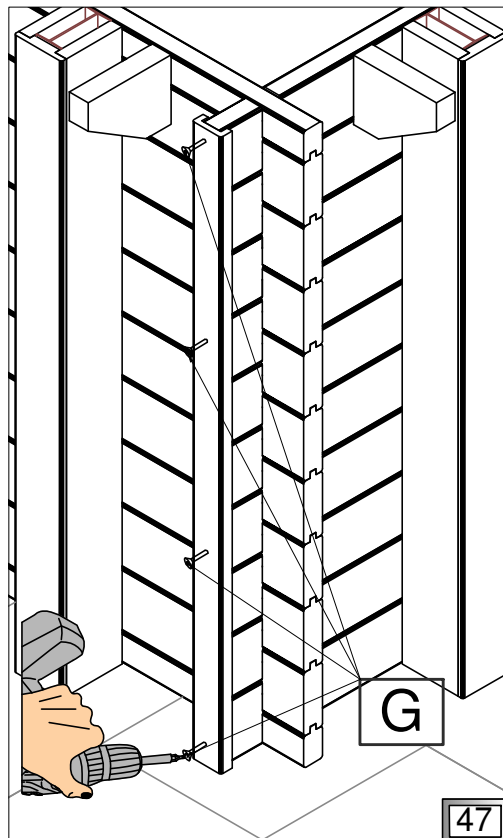
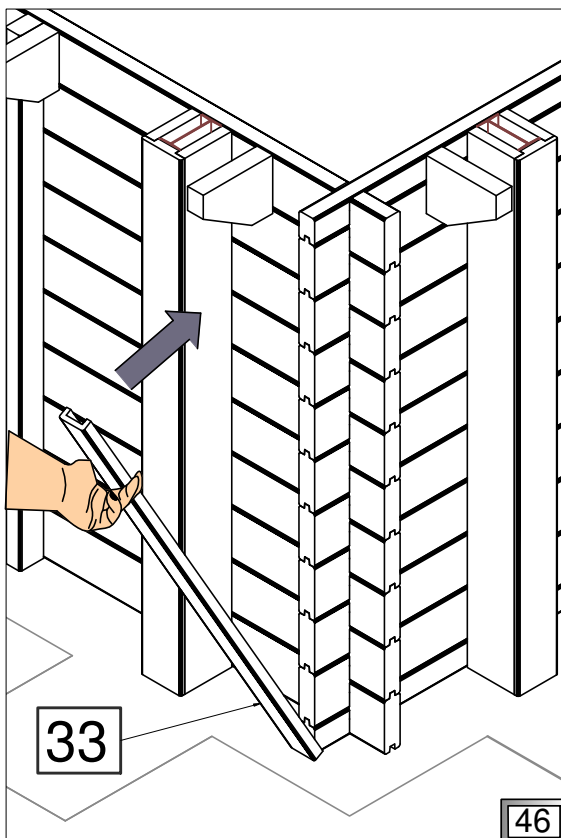
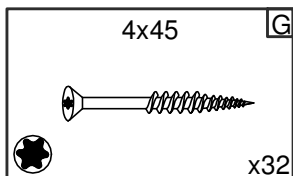
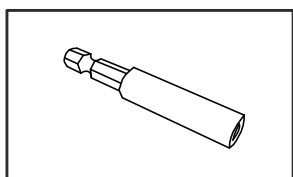
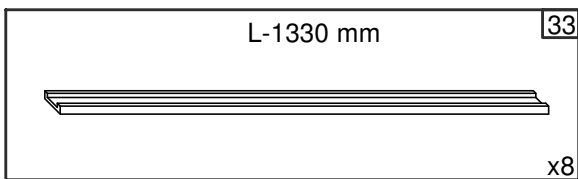
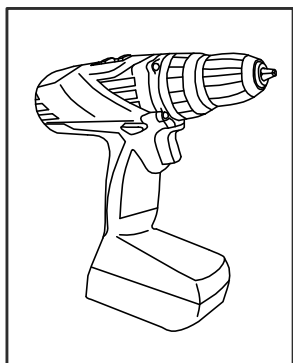

(PL) Taras

(GB) Terrace

(DE) Terrasse

(FR) Les margelles

(IT) Terrazza

(NL) Bovenrand



(PL) Montaż desek tarasowych.

(FR) Le montage des margelles.

(GB) Installation of terrace boards.

(IT) Installazione delle tavole da terrazza.

(DE) Montage vom Terrassenholz.

(NL) Installatie van de bovenrand.

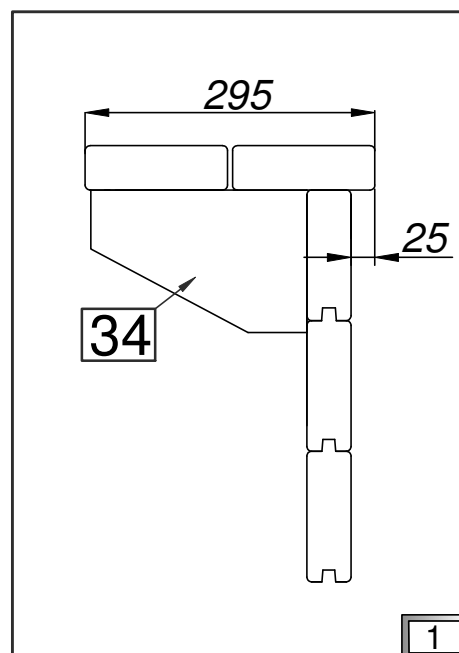
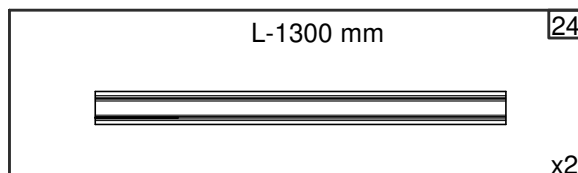
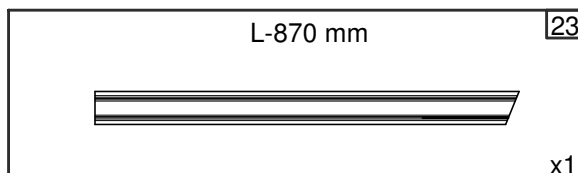
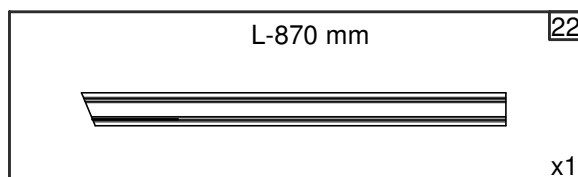
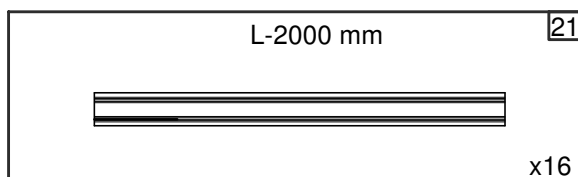
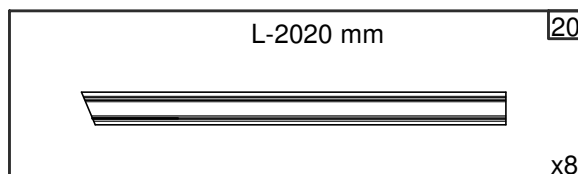
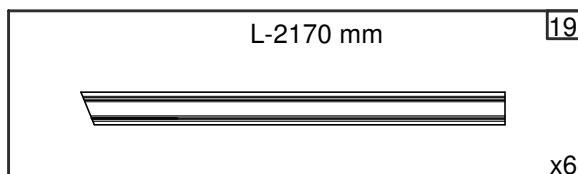
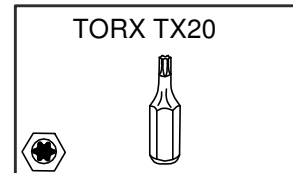
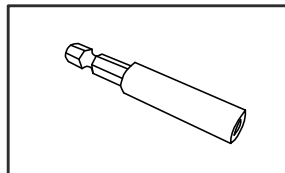
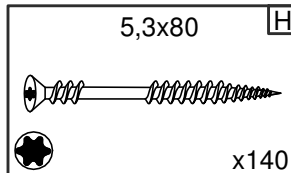
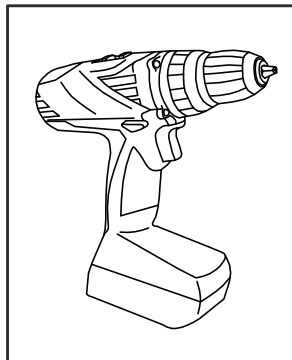

(PL) Taras

(GB) Terrace

(DE) Terrasse

(FR) Les margelles

(IT) Terrazza

(NL) Bovenrand



- (PL) Zamocuj deski tarosowe wedlug rysunku.
- (FR) Faites monter les margelles suivant le dessin.
- (GB) Mount terrace boards according to the drawing.
- (IT) Montare le tavole da terrazza secondo il disegno.
- (DE) Befestigen Sie das Terrassenholz nach der Abbildung.
- (NL) Monteer de bovenrand volgens tekening.

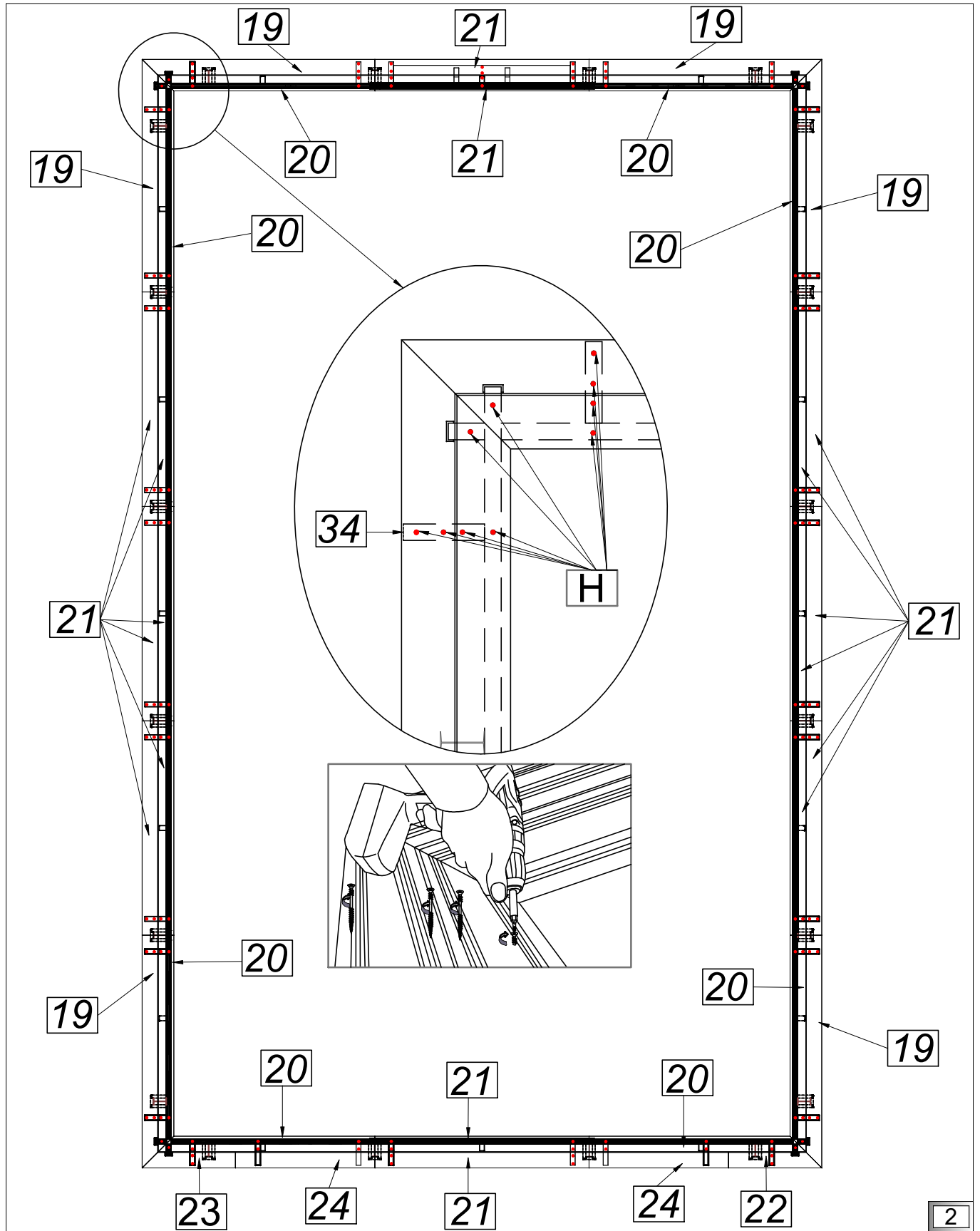

(PL) Zawiasa tarasu skimmera **(GB)** Skimmer terrace hinge **(DE)** Skimmer Terrassenscharnier
(FR) Charnière de terrasse skimmer **(NL)** Skimmer terrasscharnier



(PL) Montaż zawiasy tarasu skimmera - przykładowy sposób montażu.
(FR) Montez la charnière de terrasse du skimmer.
(GB) Mount the skimmer terrace hinge.
(IT) Montare la cerniera della terrazza skimmer.
(DE) Montieren Sie das Scharnier der Skimmerterrasse.
(NL) Monteer het terrasscharnier van de skimmer.

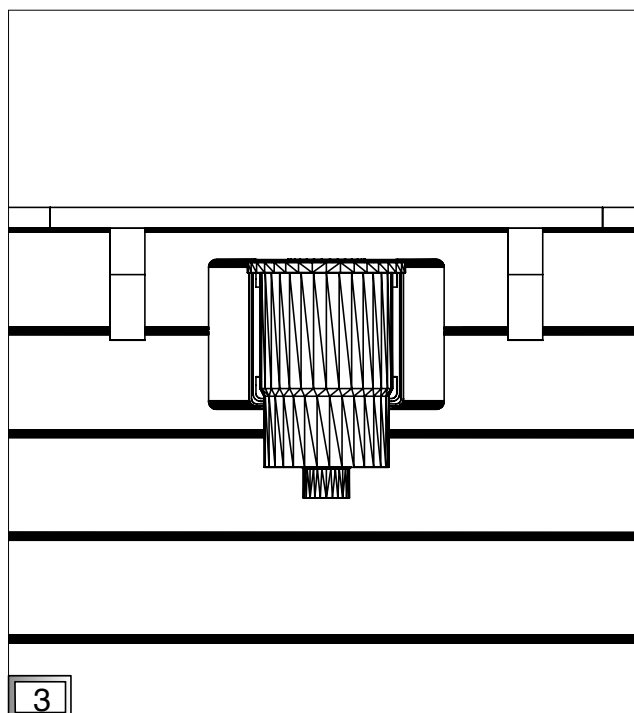
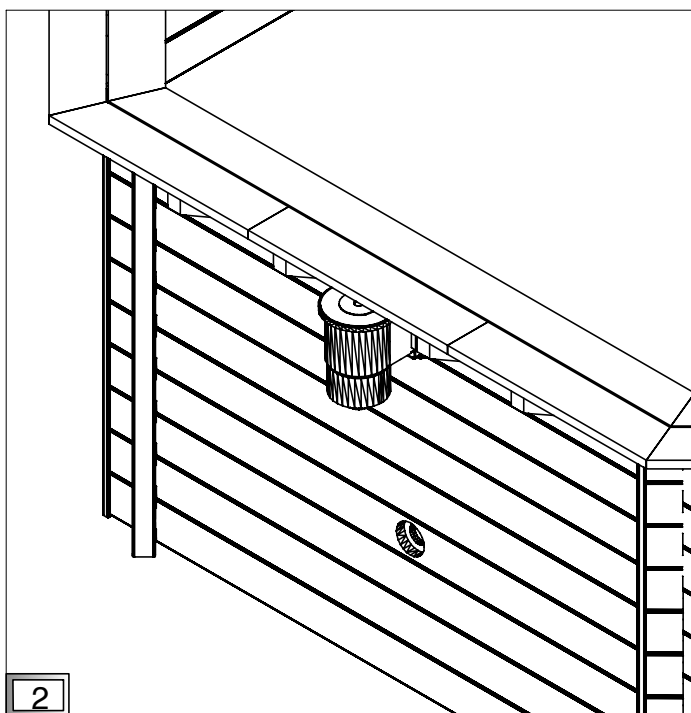
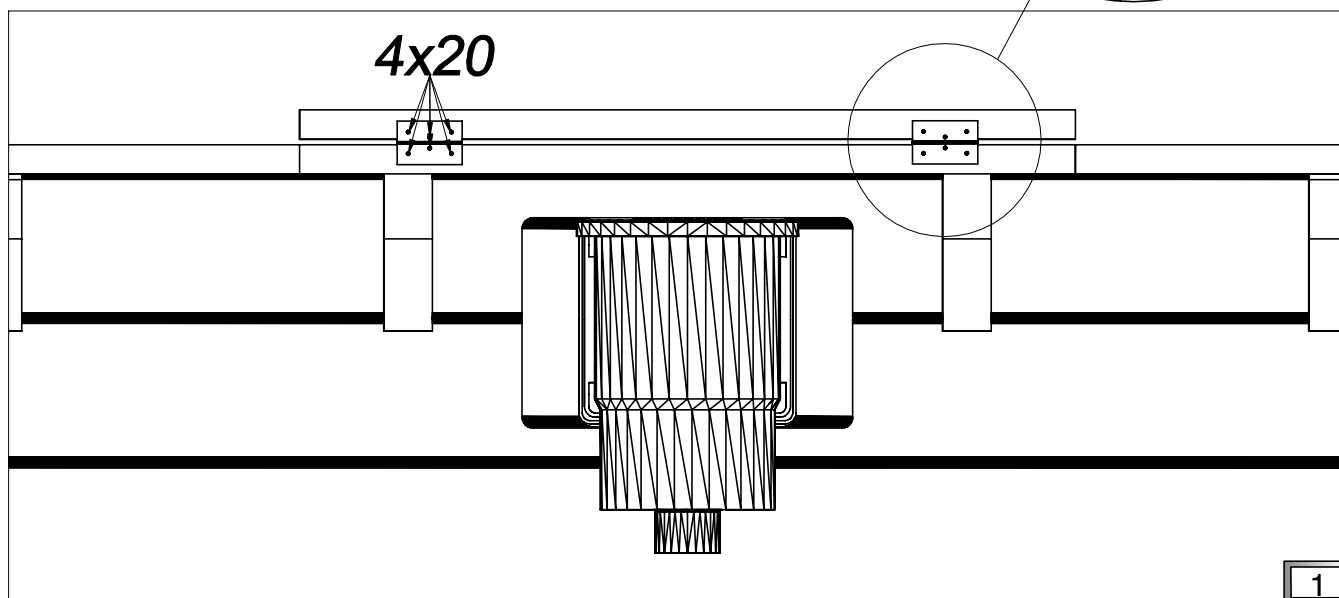
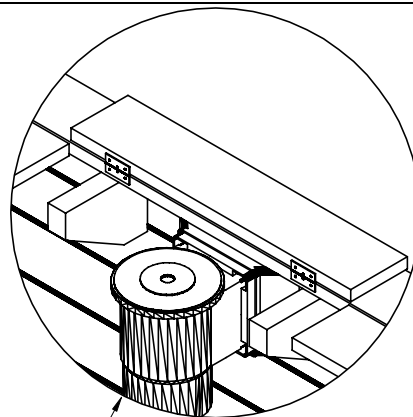
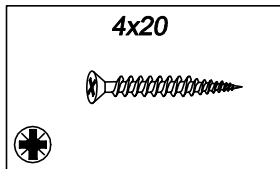
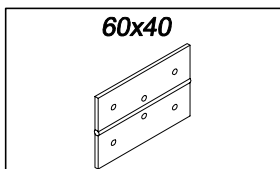

PL Struktura drewniana

GB Wooden structure

DE Holzstruktur

FR La structure bois

IT Struttura in legno

NL Houten structuur



PL Montaż łącznika karo (35) od spodu desek tarasowych.

FR Le montage des jonctions (35) en dessous des margelles.

GB Installation of wooden connector (35) to the bottom of terrace boards.

IT Montaggio di raccordo (35) dal fondo delle tavole da terrazza.

DE Montage vom Caro- Bindeglied (35) von der Unterseite des Terrassenholzes.

NL Installatie van de houten connector (35) aan de onderkant van de bovenranden.

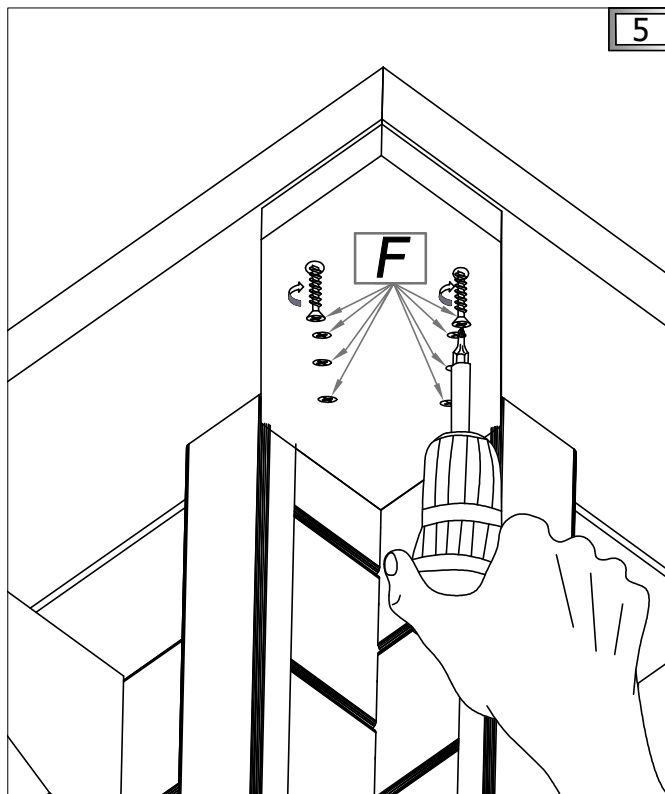
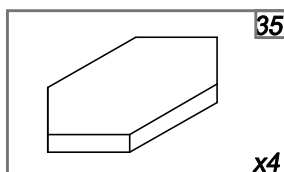
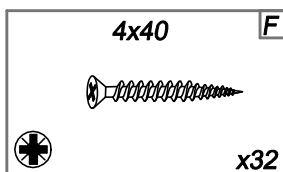
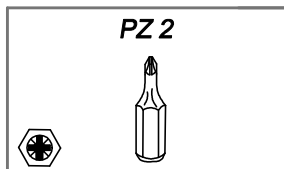
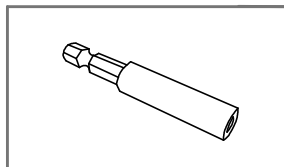
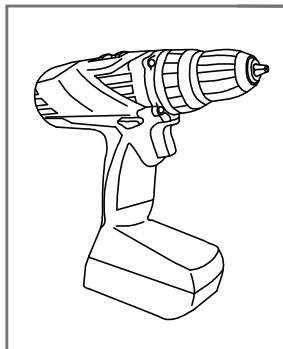

PL Widok od spodu tarasu.

FR La vue du dessous des margelles.

GB View from the bottom of terrace.

IT Vista in fondo della terrazza.

DE Sicht vom unten der Terrasse.

NL Uitzicht van de onderkant van de bovenrand.

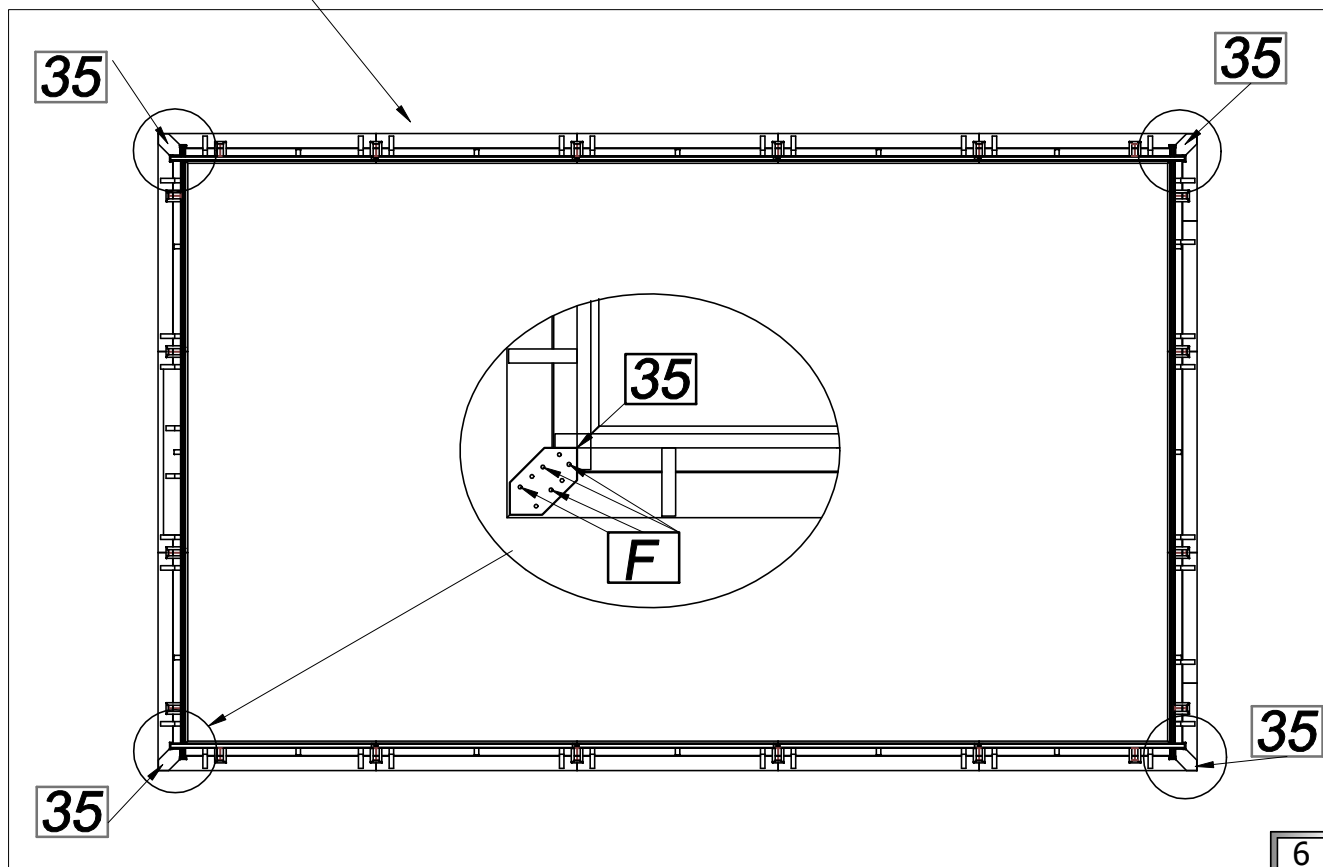

6

(PL) Schody drewniane

(GB) Wooden stairs

(DE) Holztreppe

(FR) L'escalier bois

(IT) Scale di legno

(NL) Houten trap



(PL) Montaż schodów.

(FR) Le montage de l'escalier.

(GB) Installation of stairs.

(IT) Montaggio delle scale.

(DE) Montage von Treppen.

(NL) Installatie van de houten trap.

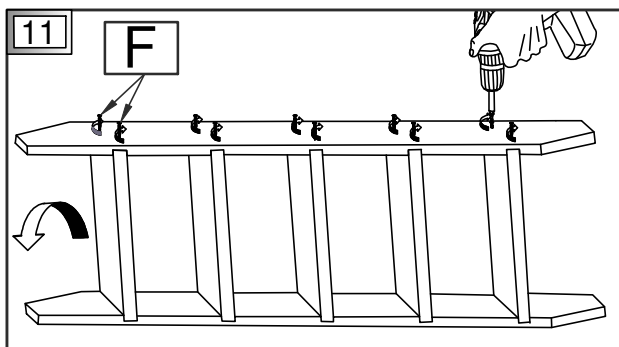
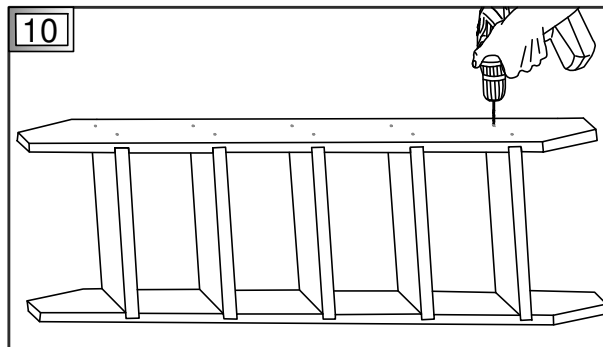
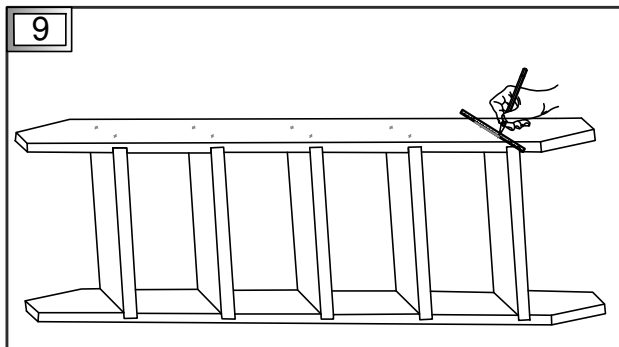
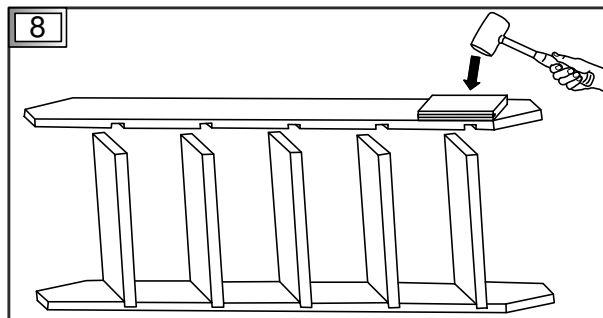
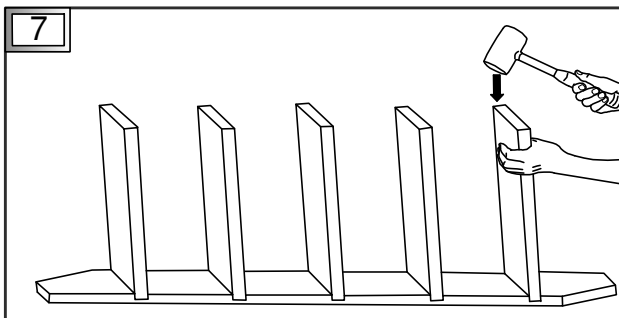
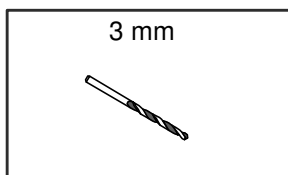
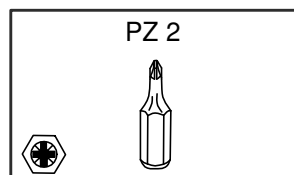
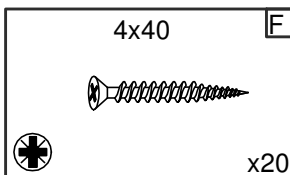
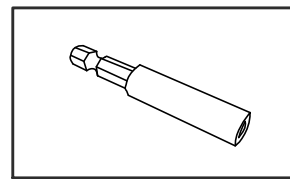
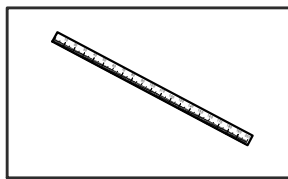
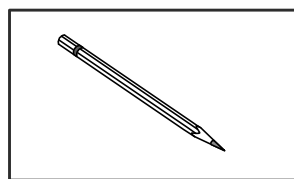
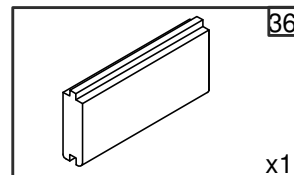
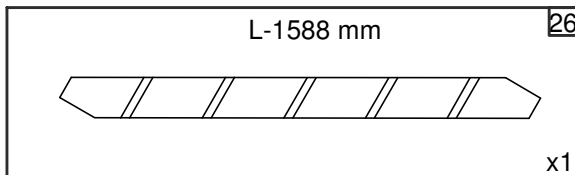
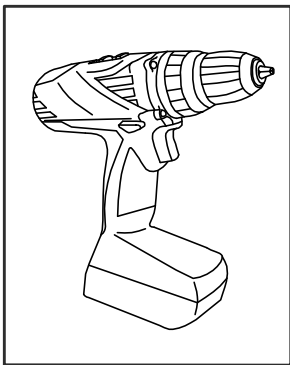
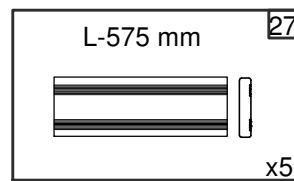
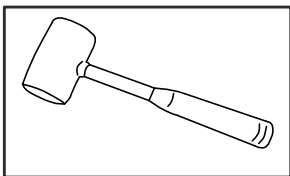

PL Schody drewniane

GB Wooden stairs

DE Holztreppe

FR L'escalier bois

IT Scale di legno

NL Houten trap



PL Montaż zawieszki (B1, B2). Schody mocujemy na ścianie ze wspornikiem schodów (28).

FR Le montage des boucles et des gâches (B1, B2). Fixez l'escalier sur la paroi avec le renfort d'escalier (28).

GB Installation of tag and hook kit (B1, B2). Stairs are mounted on the wall with stairs support (28).

IT Montaggio del manico (B1, B2). Le scale sono fissate al muro con uno sbalzo di scale (28).

DE Montage vom Gehänge (B1, B2). Die Treppe ist an die Wand mit Treppenstützen (28) zu montieren.

NL Installatie van Inhaak systeem (B1, B2). Trap wordt aan de bovenrand gemonteerd (28).

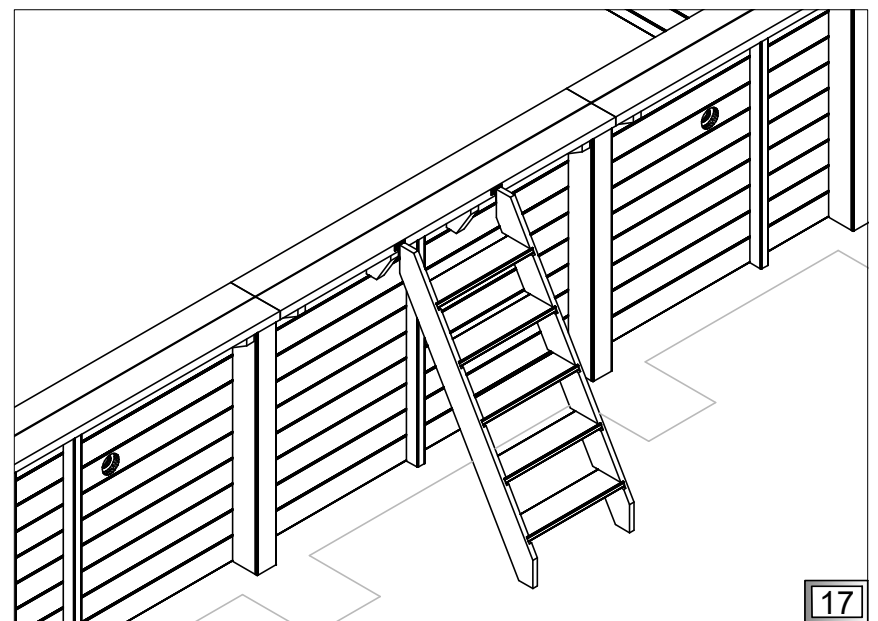
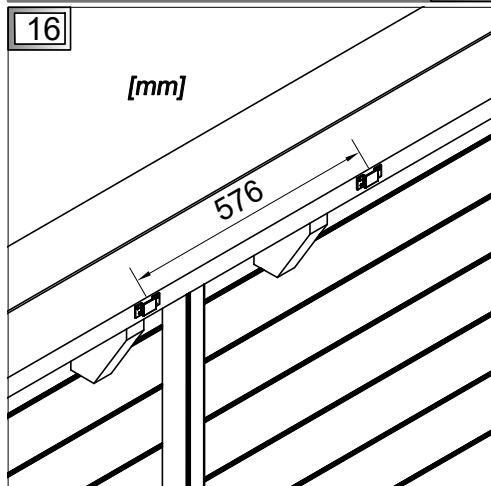
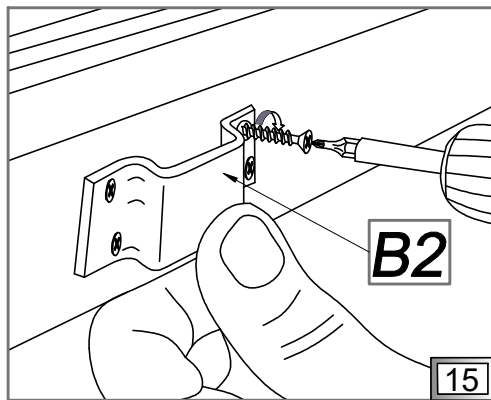
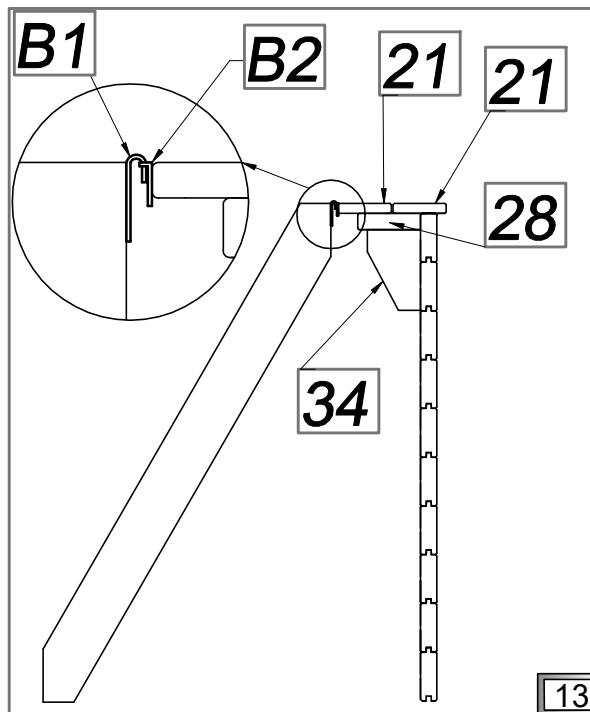
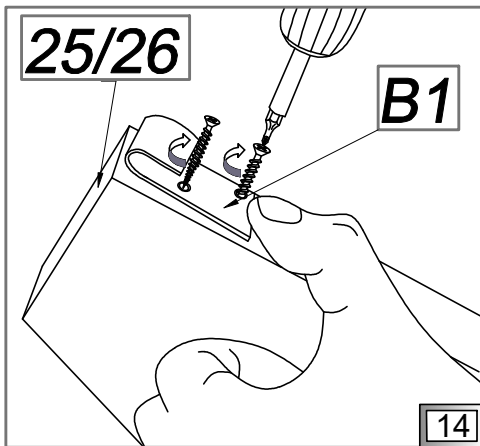
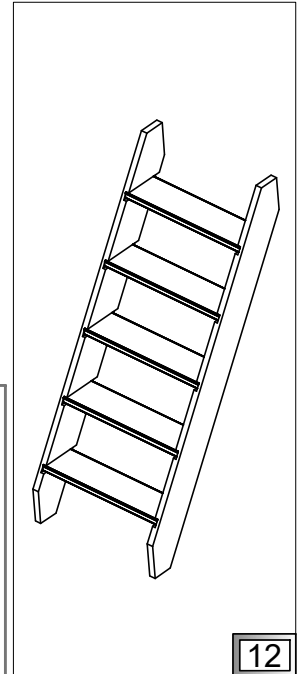
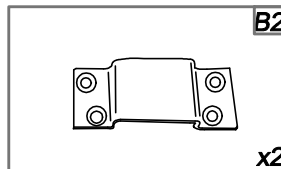
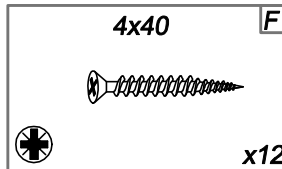
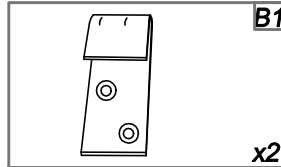
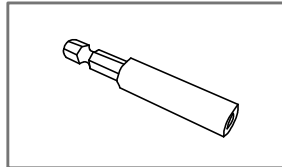
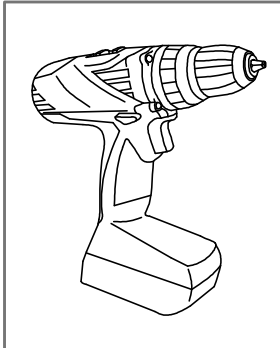

PL Maskownice

GB Corners covers

DE Abdeckungen

FR Les caches

IT Mascherini

NL Afdekkappen



- PL** Montaż maskownic (Y) do desek tarasowych.
- FR** Le montage des caches (Y) pour les margelles.
- GB** Mounting covers (Y) for corners of terrace boards.
- IT** Montaggio di mascherini (Y) per le tavole da terrazza.
- DE** Montage der Abdeckungen (Y) ans Terrassenholz.
- NL** De roestvrij afdekkappen (Y) zijn een OPTIE.

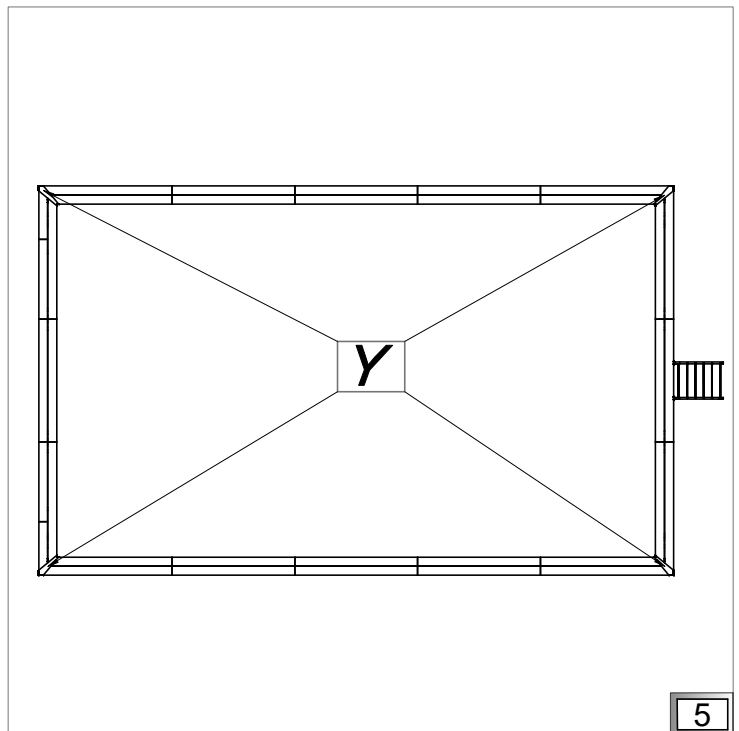
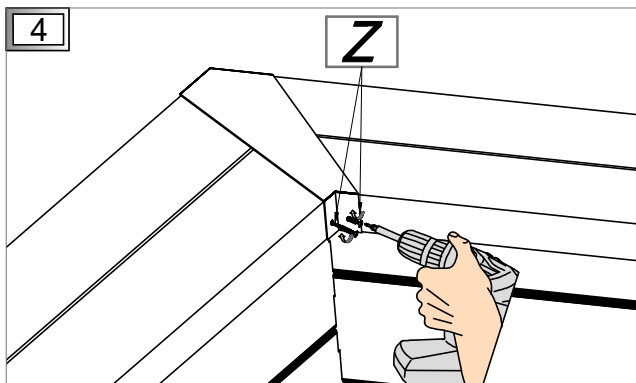
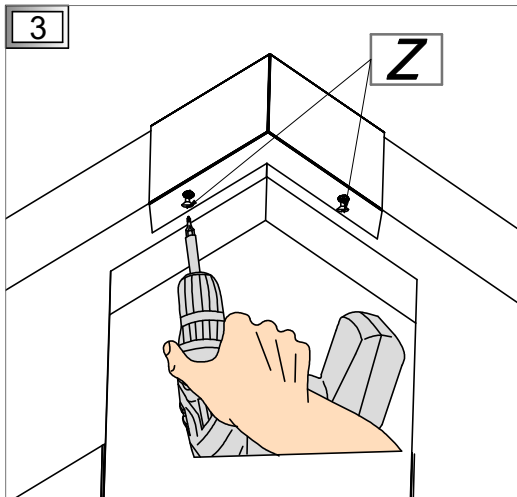
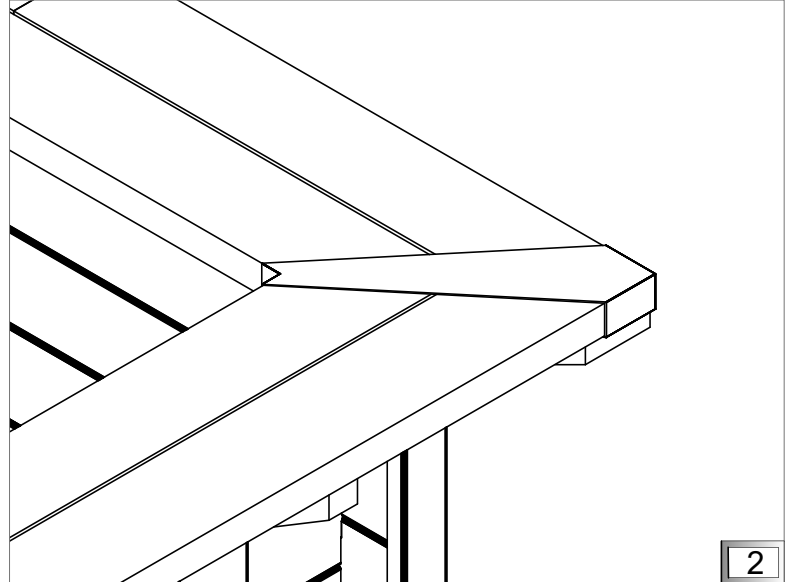
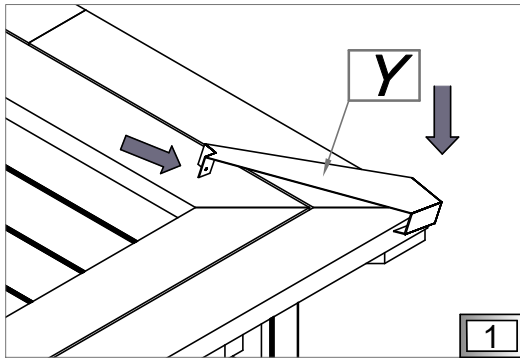
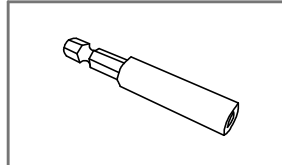
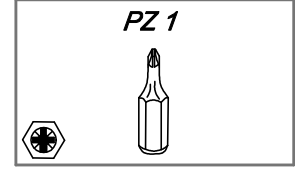
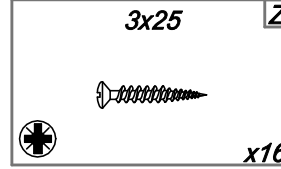
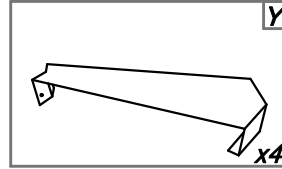
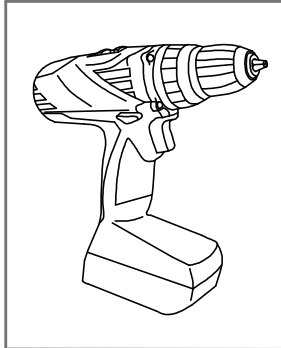

(PL) Maskownice

(GB) Corners covers

(DE) Abdeckungen

(FR) Les caches

(IT) Mascherini

(NL) Afdekkappen



- (PL)** Montaż maskownic (X) do desek tarasowych.
- (FR)** Le montage des caches (X) pour les margelles.
- (GB)** Mounting covers (X) for corners of terrace boards.
- (IT)** Montaggio di mascherini (X) per le tavole da terrazza.
- (DE)** Montage der Abdeckungen (X) ans Terrassenholz.
- (NL)** De roestvrij afdekkappen (X) voor de hoeken van de boven rand.

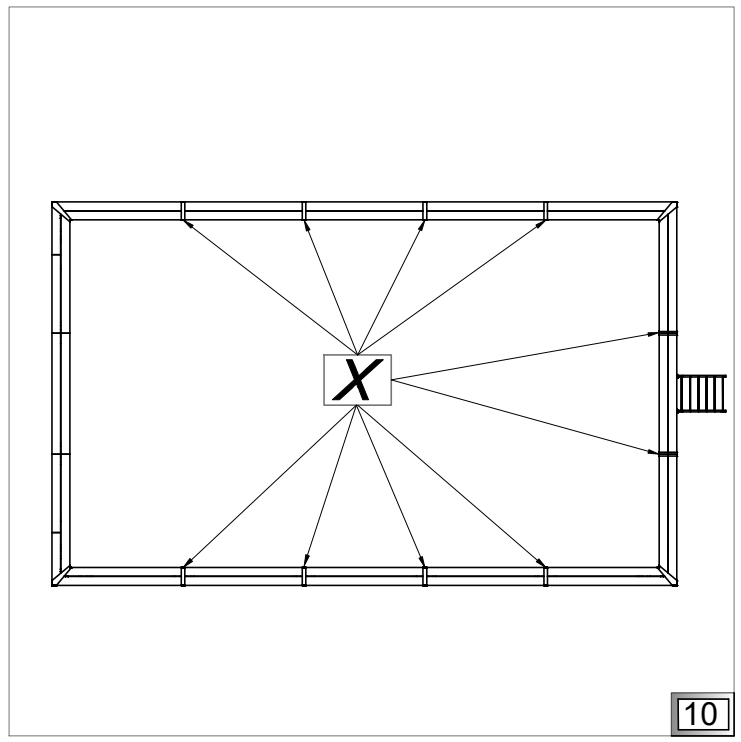
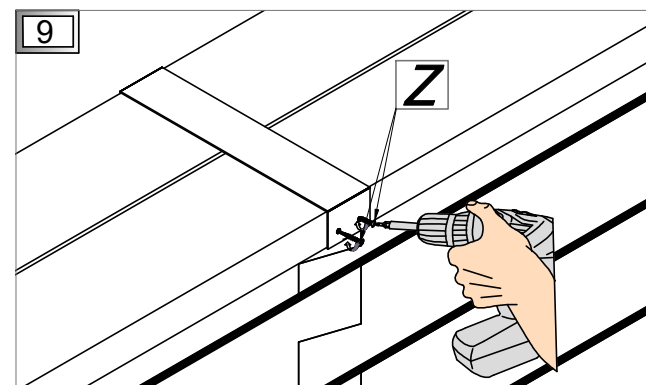
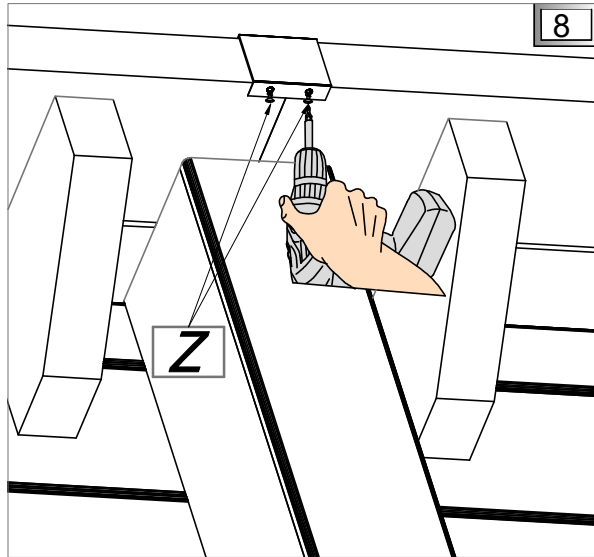
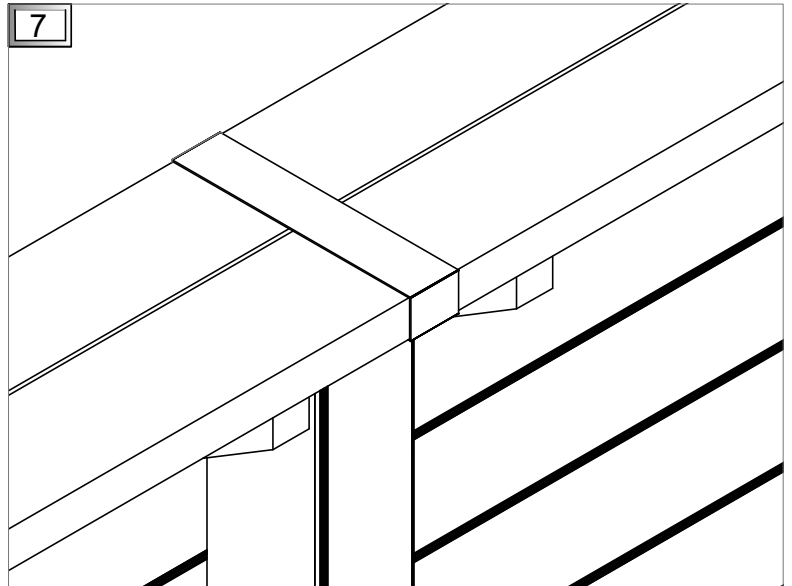
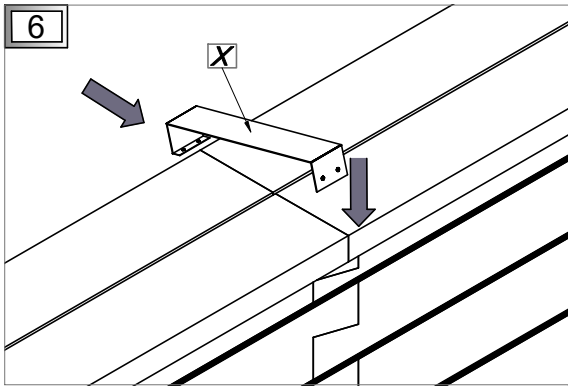
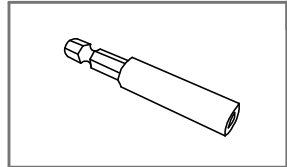
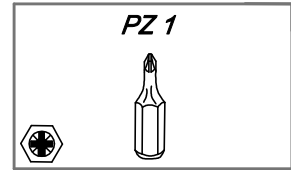
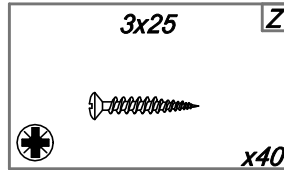
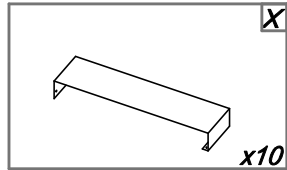
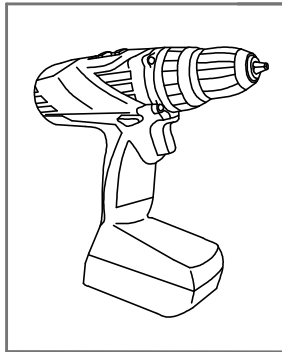

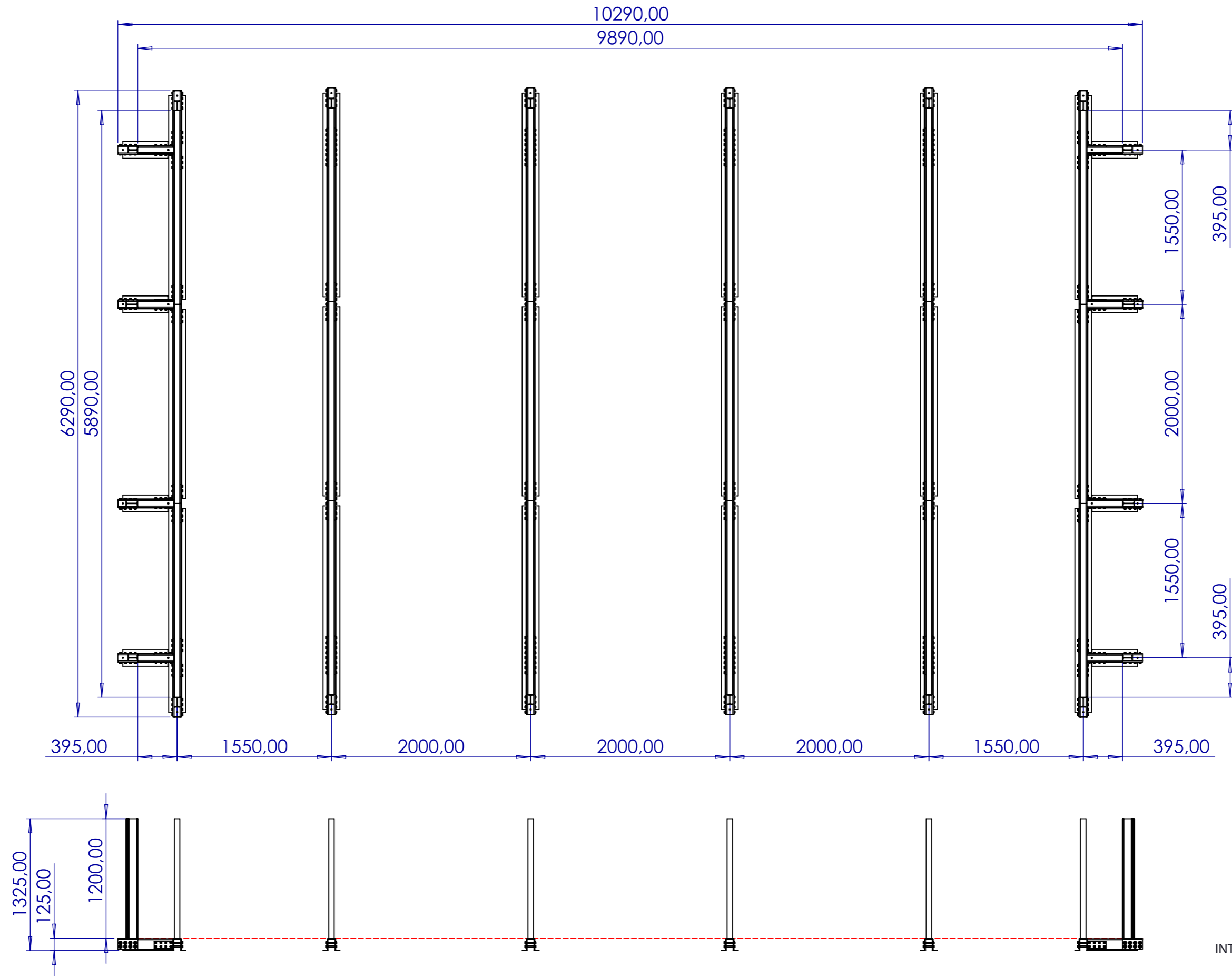

Codice Articolo 8030128

INT_0064 cod. id. unico
 INT_0064_ASS17 cod. id parte
 committente
RIVA CARRE 10x6

21/02/2020
Rev. 01
foglio 1 di 2
scala 1:40
dis. n° 13A

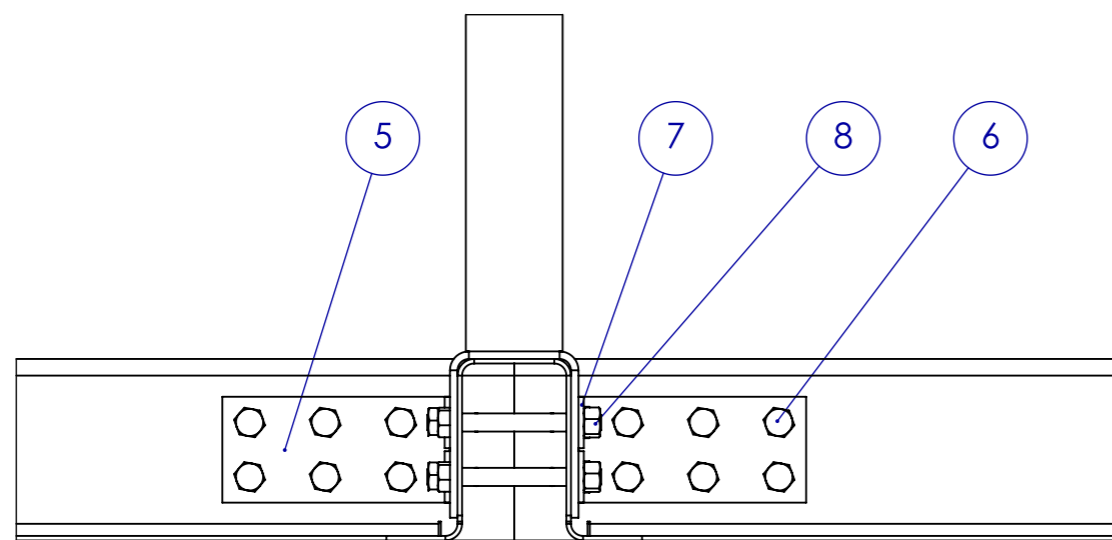
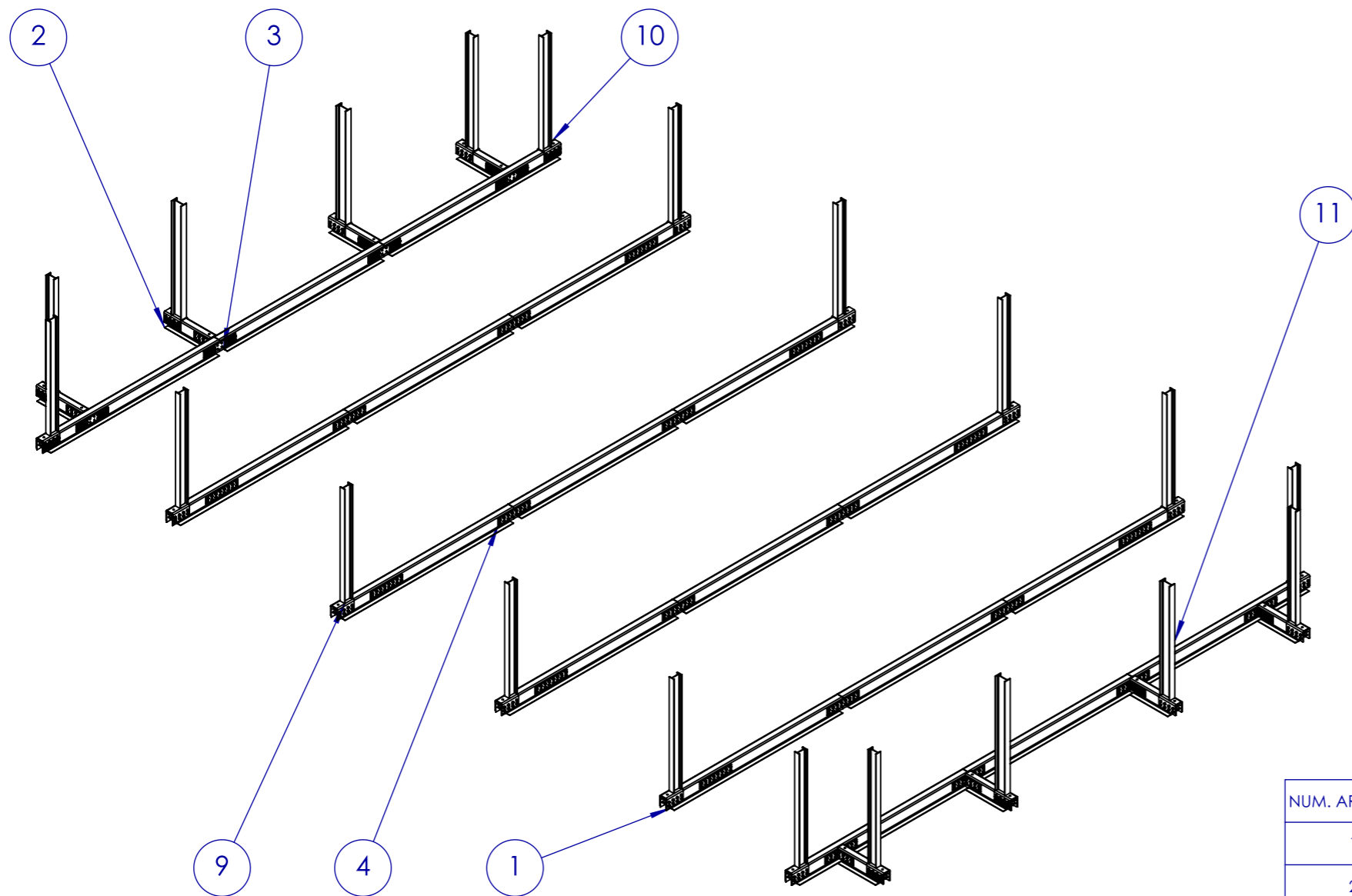

1:5

NUM. ARTICOLO	NUM. PARTE	COD ART	QUANTITÀ
1	INT_0064_11_OMEGA_2145	4030181	12
2	INT_0064_06_OMEGA_557.5	4030172	8
3	INT_0064_08_OMEGA_2000	4030180	6
4	INT_0022_13_PIASTRA_LINEARE_V01	4030039	40
5	INT_0022_14_PIASTRA_AD_ANGOLO_V01	4030040	16
6	B18.2.3.5M - HEX BOLT M12 X 1.75 X 100 --30N		576
7	B18.2.2M - PLAIN WASHER, 12 mm, REGULAR		576
8	B18.2.4.1M - HEX NUT, STYLE 1, M12 X 1.75 --D-N		576
9	INT_0064_01_IPE_100	8030140	16
10	INT_0022_09_PROFILO_U_V04	4030030	20
11	INT_0050_02B_IPE_120_1200	8030101	4

INT_0064 cod. id. unico
 INT_0064_ASS17 cod. id parte
 cod. id assieme
 committente

RIVA CARRE 10x6

21/02/2020
Rev. 01
foglio 2 di 2
scala 1:50
dis. n° 13B